

OHIO SCIENTIFIC

for

COMPUTER BOARDS 600 & 610

as used in

Challenger Series

**SUPERBOARD II
MODEL C1P
MODEL C1PMF**



GENERAL SERVICING/SAFETY PRECAUTIONS

Use an isolation transformer for bench servicing.

Maintain line voltage at 120VAC.

Remove power from unit before removing or installing chips.

Use extreme caution when handling printed circuit boards. Ground yourself before handling boards.

Do not use a soldering device which has current flowing in its tip.

Use an isolation (times 10) probe on scope.

Do not remove or install boards or minifloppy with unit turned on.

Install RAM in Chip Enable sequence only.

Caution: Ground path on the boards is parallel to the B+ path on the opposite side of the board.

DISASSEMBLY INSTRUCTIONS

Lay unit on a protective surface with top side down.

Remove six large screws from cabinet bottom and remove cabinet bottom.

Unplug minifloppy. (Model Challenger C1PMF.)

Remove five screws from Superboard II/600 board.

Lift printed board(s) from unit. Unplug power supply plug(s) and video/cassette connector from Superboard II/600 board.

Remove four screws and spacers to separate boards. (Model Challenger C1PMF only.)

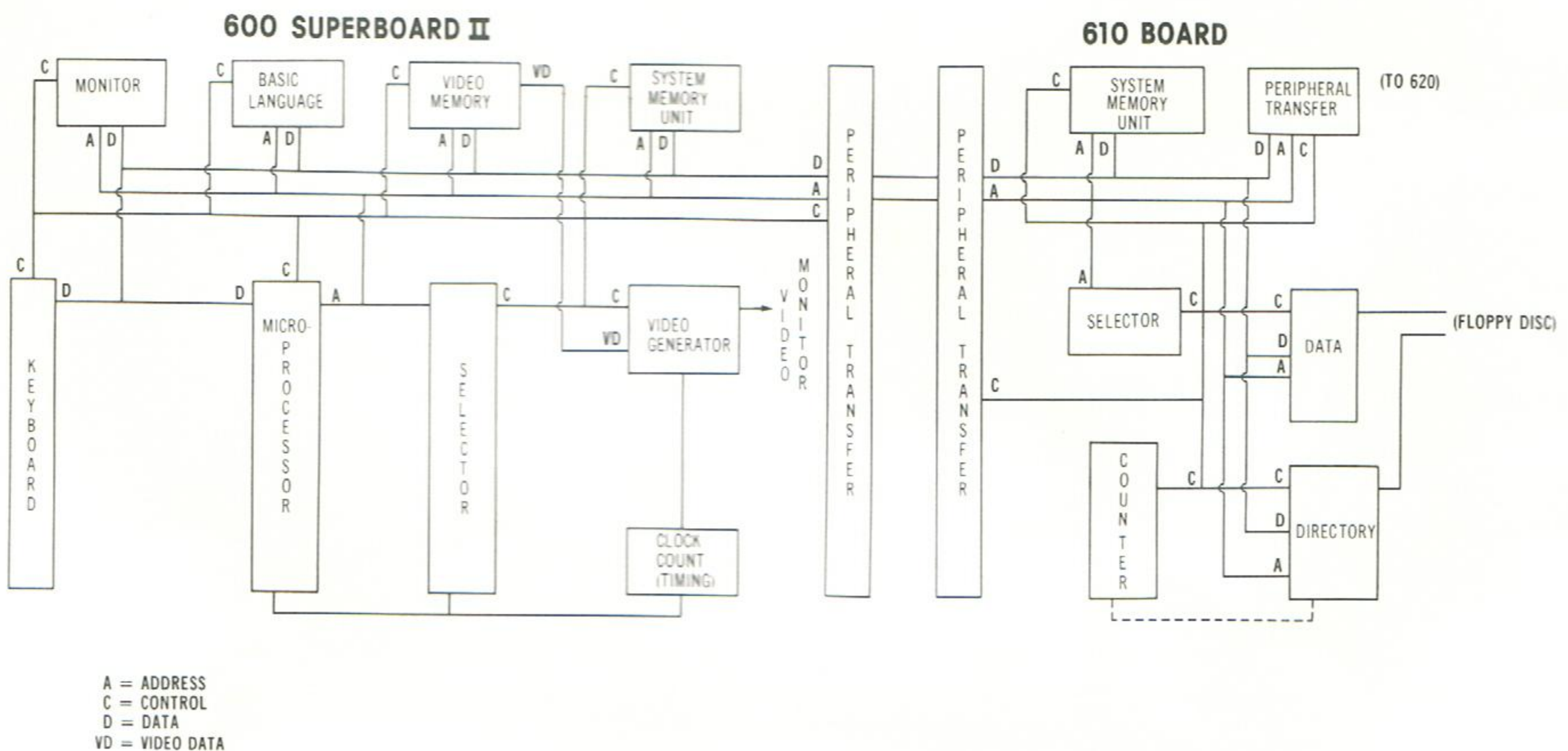

TROUBLESHOOTING GUIDE COLOR CO-ORDINATED

See schematic for the colors matching those in this guide for circuitry to be checked.

When a portion of a chip function is being referred to for checking, this is indicated by the partial coloring of chip.

PRELIMINARY SETUP

"SHIFT LOCK" key must be depressed before any troubleshooting is attempted.

"BREAK" key must be depressed and then released.

Confirm power supply(s) output of 5V DC.

These steps are necessary before computer will operate.

CRYSTAL OSCILLATOR - 600 BOARD

Connect scope to U58, Pin 8. Waveform should be similar to WAVEFORM 2. This confirms operation of X1 and associated circuitry.

Ø2 CLOCK (OSC.) - 600 BOARD

Connect scope to Pin 39 of U8. Waveform should be similar to WAVEFORM 1. This will check the operation of chip portions associated with this circuitry (U8, U30, U58).

VIDEO SIGNALS - 600 BOARD

To check video and sync pulses generated by the computer and fed to the TV monitor, connect scope to VIDEO JACK (J6). Waveforms should be similar to WAVEFORMS 9 and 10. WAVEFORMS 3 through 8 aid in checking circuits used in video development. See U30 for scope connections.

These steps basically verify operation of circuitry that generates VIDEO and SYNC pulses. Effectively, this will check U30, U59, U60, U61, U65, U69 and parts of U56, U62, and U70.

"BYTES FREE" MEMORY CHECK - 600 & 610 BOARDS

The ram circuitry check is built into the computer, as long as most all other circuitry is working.

To check ram circuitry, follow this procedure:

1. Press "BREAK".
2. Press "C".

Computer will ask "memory size". Ignore the question, press "RETURN".

Computer will ask "terminal width". Ignore the question, press "RETURN".

Computer will display XXXX BYTES free, etc.

If the "BYTES FREE" number does not represent the total number of your system, this will indicate what memory or associated circuitry has failed.

The following chart indicates the byte free count and the chips involved.

To find the defective memory rams or associated circuitry, observe bytes free indication on screen.

Go to the following chart and find the bytes free column to locate associated chips.

EXAMPLE 1: The computer is equipped with MEMORY totaling 19,711 BYTES FREE.

The monitor screen indicates 12,543 bytes free. Go to Chart 12,543. Adjacent chips U23 and U31 are operating properly.

This would indicate, then, that U24 and/or U32 and/or associated circuitry is malfunctioning.

EXAMPLE 2: The computer is equipped with MEMORY totaling 19,711 BYTES FREE.

The monitor screen indicates 12,540 bytes free. Go to chart. 12,540 falls between 11,519 and 12,543.

This indicates U23 and/or U31 and/or associated circuitry is malfunctioning.

NOTE: Chips adjacent to the next higher number of bytes free displayed on the monitor are the most likely defective device(s).

If above steps do not solve failure(s), continue.

CHIP SELECT LINES (RS(0 thru 7) AND CE(0 thru 23))

To check chip select lines, bring the computer into machine language mode by depressing "BREAK", then "M". A six-character alpha-numeric display will appear on the monitor. Use the first four characters for the address code as shown charted below. Connect logic probe to chip select line.

Press "." then enter address selected from chart. If operating properly a pulse should be indicated on logic probe when the last character is entered.

RAMS

BYTES FREE	CHIPS OR ASSOCIATED CIRCUITRY	MACHINE ADDRESS NUMBERS	
255	U31 U45	0000-03FF	600 BOARD
1279	U32 U46	0400-07FF	"
2303	U33 U47	0800-0BFF	"
3327	U34 U48	0C00-0FFF	"
		 4K
4351	U35 U49	1000-13FF	600 BOARD
5375	U36 U50	1400-17FF	"
6399	U37 U51	1800-1BFF	"
7423	U38 U52	1C00-1FFF	"
		 8K
8447	U19 U27	2000-23FF	610 BOARD
9471	U20 U28	2400-27FF	"
10495	U21 U29	2800-2BFF	"
11519	U22 U30	2C00-2FFF	"
12543	U23 U31	3000-33FF	"
13567	U24 U32	3400-37FF	"
14591	U25 U33	3800-3BFF	"
15615	U26 U34	3C00-3FFF	"
		 16K
16639	U35 U43	4000-43FF	610 BOARD
17663	U36 U44	4400-47FF	"
18687	U37 U45	4800-4BFF	"
19711	U38 U46	4C00-4FFF	"
		 20K
20735	U39 U47	5000-53FF	610 BOARD
21759	U40 U48	5400-57FF	"
22783	U41 U49	5800-5BFF	"
23807	U42 U50	5C00-5FFF	"
24831	U51 U59	6000-63FF	"
25855	U52 U60	6400-67FF	"
26879	U53 U61	6800-6BFF	"
27903	U54 U62	6C00-6FFF	"
28927	U55 U63	7000-73FF	"
29951	U56 U64	7400-77FF	"
30975	U57 U65	7800-7BFF	"
31999	U58 U66	7C00-7FFF	"

MINIFLOPPY SIGNAL CHECK - 610 BOARD

MINIFLOPPY must be in "disk" operating mode by depressing "BREAK" then "D".

To check for the computer pulse required to get the signal "to" and "from", waveforms should be similar to WAVEFORMS 21, 22, 23, and 24.

For computer output data to minifloppy in "directory cycle", check for "grass" as shown in WAVEFORM 25 while in this "directory cycle".

NOTE: This cycle takes place immediately after depressing "BREAK" and then "D".

For proper operation of computer output program data (to minifloppy) with computer in the "disk storage" mode, check for "grass" as shown in WAVEFORM 27.

To check for data from the minifloppy, select program from disk selection shown on monitor.

Select program, depress "RETURN" and check immediately during the selection cycle for "grass" as shown in WAVEFORM 26.

AUDIO CASSETTE/TAPE SIGNAL CHECK - 600 BOARD

Computer circuitry handling signals going to cassette should be similar to WAVEFORMS 16 and 17.

When storing a program going out to tape recorder, see WAVEFORMS 18, 19, and 20.

To confirm signal coming from cassette: while loading a program coming from the cassette, proper operation is indicated by WAVEFORMS 11, 12, 13, 14, and 15. WAVEFORM 15 amplitude will depend on volume control setting of cassette.

MICROPROCESSOR CHIP (CPU) OPERATION - 600 BOARD

If "BREAK" key does not clear screen of random pattern, processor may not be working. Be sure key switch is functioning.

To verify processor is working, a pulse indication taken by scope (set on 1 μ Sec. range) or logic probe at address lines (A0 through A15) at U8 will verify. No signal on an address line will suggest a defective U8 or a problem on that address line.

ROM MONITOR AND ROM BASIC CHIPS OPERATION CHECK

SYMPTOM: "BASIC" mode will not operate as "C" key is depressed and display does not change. The "DISK" mode as well as "MACHINE" mode operate properly. This indicates a problem with ROM BASIC 1, 2, 3 (U9, U10, U11).

SYMPTOM: "BASIC", "DISK", AND "MACHINE" modes not functioning. This indicates a problem with one or more of these chips and/or associated circuitry;

ROM MONITOR (U13)
ROM BASIC 4 (U12)
MICROPROCESSOR (CPU-U8)
RAMS (U31 AND/OR U45)

600 BOARD PARTS LIST AND DESCRIPTION

(When ordering parts, state Model, Part Number, and Description.)

SEMICONDUCTORS (Select replacement transistor for best results)

ITEM No.	TYPE No.	MFR. PART No.	REPLACEMENT DATA							
			GENERAL ELECTRIC PART No.	MALLORY PART No.	RAYTHEON PART No.	RCA PART No.	SYLVANIA PART No.	THORDARSON PART No.	WORKMAN PART No.	ZENITH PART No.
D1-D10 D15 D16 D17-D20 Q1	1N914 1N4001 1N914 1N914	Q-1N914 Q-1N4001	GE-514 GE-504A GE-514 GE-514	PTC214 1N4001 PTC214 PTC214	REN 177 REN 116 REN 177 REN 177	SK3100/519 SK3312 SK3100/519 SK3100/519	ECG519 ECG116 ECG519 ECG519	TM519 TM116 TM519 TM519	WEP925/519 WEP156 WEP925/519 WEP925/519	103-131 212-76-02 103-131 103-131
Q2 U2-U3 U4-U5 U6-U7 U8	SN74LS75N 74125N 74LS125 MC8T28P 6502	IC-74LS75 IC-74LS125 IC-8T28 IC-6502				SK74LS75	ECG74LS75 ECG74125 ECG74125	TM74LS75 TM74125 TM74125		
U9 U10 U11 U12 U13	BASIC 1 BASIC 2 BASIC 3 BASIC 4 SYN600 2316B 2716(1)	IC-BASIC 1 IC-BASIC 2 IC-BASIC 3 IC-BASIC 4 IC-SYN600								
U14 U15 U16 U17 U18	S6850P 74LS02N 74LS04PC SN74LS139N 74LS04PC	IC-6850 IC-74LS02 IC-74LS04 IC-74LS139 IC-74LS04	GE-7404			SK74LS02 SK74LS04 SK74LS04	ECG74LS02 ECG74LS04 ECG74LS04	TM74LS02 TM74LS04 TM74LS04	WEP7402/7402	221-29076 221-29076
U19 U20 U21 U22-U23 U24-U25	SN74LS20J SN74LS138N 74LS04PC 74LS138N MC8T28P	IC-74LS20 IC-74LS138 IC-74LS04 IC-74LS138 IC-8T28				SK74LS20 SK74LS138 SK74LS04 SK74LS138	ECG74LS20 ECG74LS138 ECG74LS04 ECG74LS138	TM74LS20 TM74LS138 TM74LS04 TM74LS138		
U29 U30	7492 74LS92 74163N 74LS163	IC-74LS163 IC-L2114-550	GE-7492			SK7492 SK74LS163	ECG7492 ECG74163 ECG74LS163A	TM7492 TM74163 TM74LS163A		
U31-U40 U41 U42 U43 U44 U45-U52 U53-U55	L2114-550 CARGENV1.0 SN74LS165N 7408N L2114-550 74LS157N	IC-CARGEN IC-74LS165 IC-7408 PROTO IC-L2114-550 IC-74LS157	GE-7408			SK74LS157	ECG74165 ECG7408	TM74165 TM7408	WEP7408/7408	
U56 U57 U58	SN74LS20J 74LS163N DM7400N 74LS00	IC-74LS20 IC-74LS163 IC-7400	GE-7400		REN 7400	SK74LS20 SK74LS163 SK74LS00 SK74LS00	ECG74LS20 ECG74LS163A ECG7400 ECG74LS00	TM74LS20 TM74LS163 TM7400 TM74LS00	WEP7400/7400 WEP7400/7400	221-29075
U59-U61 U62	74163N 74LS163 F5404DM 7404	IC-74LS163	GE-7404			SK74LS163 SK7404	ECG74163 ECG74LS163A ECG7404	TM74163 TM74LS163A TM7404		221-29076
U63 U64	SN7474N 74LS74 SNC5476J 7476 74LS76	IC-74LS74	GE-7474		REN 7474	SK7474 SK74LS74 SK7476	ECG7474 ECG74LS74A ECG7476	TM7474 TM74LS74A TM7476	WEP7474/7474 WEP7476/7476	
U65 U66 U67	SN74123N 74LS123 CA3130S 7414 74LS14	IC-74123 IC-3130	GE-74123		REN 74123	SK74123 SK74LS123 SK3568 SK7414 SK74LS14	ECG74123 ECG74LS123 ECG7414 ECG74LS14	TM74123 TM74LS123 TM7414 TM74LS14		221-29086
U68 U69	7417 74LS17 SN74123N 74LS123	IC-74123	GE-74123		REN 74123	SK74123 SK74LS123	ECG74123 ECG74LS123	TM74123 TM74123		221-29086
U70	7403N 74LS03 JOY STICK & SOUND 1N914	IC-7403				SK74LS03	ECG7403 ECG74LS03	TM7403 TM74LS03		
			GE-514	PTC214	REN 177	SK3100/519	ECG519	TM519	WEP925/519	103-131

(1) Used in some versions.

ELECTROLYTIC CAPACITORS

ITEM No.	RATING	REPLACEMENT DATA				
		MFR. PART No.	CORNELL-DUBILIER PART No.	MALLORY PART No.	SPRAGUE PART No.	
					Q-LINE	GENERAL LINE
C5	47 16V 33	C-506	WBR50-25 WBR35-50	TT25X50A TT15X30A	QE1-353 QE1-309	TVA-1206 TVA-1205.1

600 BOARD PARTS LIST AND DESCRIPTION (CONTINUED)

(When ordering parts, state Model, Part Number, and Description.)

CAPACITORS

ITEM No.	RATING	MFR. PART No.	REPLACEMENT DATA			
			CORNELL-DUBILIER PART No.	MALLORY PART No.	SPRAGUE PART No.	
					Q-LINE	GENERAL LINE
C6	150pF 5%	C-151	CD15FD151J03	SX315	QW1-31	MWA-151
C7	.001 100V 10%	C-102	CD19FD102J03	SX210	QW1-51	MWC-102
C8	.1 50V 10%	C-104	WMF05P1	EFW05010		431P1049R5
C9	68pF 5%	C-680	CD15ED680J03	SX468	QW1-23	MWA-680
C10	.01 100V 10%	C-103	WMF1S1	EFW1A110	QF1-91	1PB-S10
C11	.1 50V 10%	C-104	WMF05P1	EFW05010		431P1049R5
C12	.001 100V 10%	C-102	CD19FD102J03	SX210	QW1-51	MWC-102
C13	.01 100V 10%	C-103	WMF1S1	EFW1A110	QF1-91	1PB-S10
C21	.1 10V	CB-10410	MGP1	MAG1201	QC1-223	HY-360
C22	.1 10V	CB-10410	MGP1	MAG1201	QC1-223	HY-360
C23	.1 10V	CB-10410	MGP1	MAG1201	QC1-223	HY-360
C24	.1 10V	CB-10410	MGP1	MAG1201	QC1-223	HY-360
C25	.1 10V	CB-10410	MGP1	MAG1201	QC1-223	HY-360
C26	.1 10V	CB-10410	MGP1	MAG1201	QC1-223	HY-360
C27	.1 10V	CB-10410	MGP1	MAG1201	QC1-223	HY-360
C28	.1 10V	CB-10410	MGP1	MAG1201	QC1-223	HY-360
C29	.1 10V	CB-10410	MGP1	MAG1201	QC1-223	HY-360
C30	.1 10V	CB-10410	MGP1	MAG1201	QC1-223	HY-360
C32	.1 10V	CB-10410	MGP1	MAG1201	QC1-223	HY-360
C33	.1 10V	CB-10410	MGP1	MAG1201	QC1-223	HY-360
C35	.1 10V	CB-10410	MGP1	MAG1201	QC1-223	HY-360
C36	.1 10V	CB-10410	MGP1	MAG1201	QC1-223	HY-360
C37	.1 10V	CB-10410	MGP1	MAG1201	QC1-223	HY-360
C38	.1 10V	CB-10410	MGP1	MAG1201	QC1-223	HY-360
C39	.1 10V	CB-10410	MGP1	MAG1201	QC1-223	HY-360
C40	.1 10V	CB-10410	MGP1	MAG1201	QC1-223	HY-360
C41	.1 10V	CB-10410	MGP1	MAG1201	QC1-223	HY-360
C42	.1 10V	CB-10410	MGP1	MAG1201	QC1-223	HY-360
C43	.1 10V	CB-10410	MGP1	MAG1201	QC1-223	HY-360
C44	.1 10V	CB-10410	MGP1	MAG1201	QC1-223	HY-360
C45	.1 10V	CB-10410	MGP1	MAG1201	QC1-223	HY-360
C46	.1 10V	CB-10410	MGP1	MAG1201	QC1-223	HY-360
C47	.1 10V	CB-10410	MGP1	MAG1201	QC1-223	HY-360
C48	.1 10V	CB-10410	MGP1	MAG1201	QC1-223	HY-360
C49	.1 10V	CB-10410	MGP1	MAG1201	QC1-223	HY-360
C50	.1 10V	CB-10410	MGP1	MAG1201	QC1-223	HY-360
C51	.1 10V	CB-10410	MGP1	MAG1201	QC1-223	HY-360
C52	.1 10V	CB-10410	MGP1	MAG1201	QC1-223	HY-360
C53	.1 10V	CB-10410	MGP1	MAG1201	QC1-223	HY-360
C54	.1 10V	CB-10410	MGP1	MAG1201	QC1-223	HY-360
C55	.001 100V 10%	C-102				
C56	.1 10V		MGP1	MAG1201	QC1-223	HY-360
C57	27pF 1KV 10%	C-270				
C58	.1 10V	CB-10410	MGP1	MAG1201	QC1-223	HY-360
C59	.1 10V	CB-10410	MGP1	MAG1201	QC1-223	HY-360

CONTROLS (All wattages 1/2 watt, or less, unless listed)

ITEM No.	FUNCTION	RESISTANCE	REPLACEMENT DATA		
			MFR. PART No.	MALLORY PART No.	TRW PART No.
R57	Duration (Tape Pulse)	10K	RP-103		
R58	Video	5000	RP-502		

RESISTORS

ITEM No.	RATING	REPLACEMENT DATA		ITEM No.	RATING	REPLACEMENT DATA	
		MFR. PART No.	WORKMAN PART No.			MFR. PART No.	WORKMAN PART No.
R1	4700 1/4W 5%	R1-472	22-1112	R47	390 1/4W 5%	R1-391	22-1086
R2	4700 1/4W 5%	R1-472	22-1112	R48	220 1/4W 5%	R1-221	22-1080
R3	4700 1/4W 5%	R1-472	22-1112	R49	390 1/4W 5%	R1-391	22-1086
R4	4700 1/4W 5%	R1-472	22-1112	R50	15K 1/4W 5%	R1-153	22-1124
R5	4700 1/4W 5%	R1-472	22-1112		10K 1/4W 5%	R1-103	22-1120
R6	4700 1/4W 5%	R1-472	22-1112	R51	220 1/4W 5%	R1-221	22-1080
R7	4700 1/4W 5%	R1-472	22-1112	R52	1000 1/4W 5%	R1-102	22-1096
R8	4700 1/4W 5%	R1-472	22-1112	R53	10K 1/4W 5%	R1-103	22-1120
R9	220 1/4W 5%	R1-221	22-1080	R54	1000 1/4W 5%	R1-102	22-1096
R10	4700 1/4W 5%	R1-472	22-1112	R55	10K 1/4W 5%	R1-103	22-1120
R11	4700 1/4W 5%	R1-472	22-1112	R56	100K 1/4W 5%	R1-104	22-1144
R12	4700 1/4W 5%	R1-472	22-1112	R59	1000 1/4W 5%	R1-102	22-1096
R32	1000 1/4W 5%	R1-102	22-1096	R60	470 1/4W 5%	R1-471	22-1088
R33	10K 1/4W 5%	R1-103	22-1120	R61	220 1/4W 5%	R1-221	22-1080
R34	10K 1/4W 5%	R1-103	22-1120	R62	4700 1/4W 5%	R1-472	22-1112
R35	470 1/4W 5%	R1-471	22-1088	R62A	100 1/4W 5%	R1-101	22-1072
R36	470 1/4W 5%	R1-471	22-1088	R63	10K 1/4W 5%	R1-103	22-1120
R37	10K 1/4W 5%	R1-103	22-1120	R64	10K 1/4W 5%	R1-103	22-1120
R38	220 1/4W 5%	R1-221	22-1080	R65	470 1/4W 5%	R1-471	22-1088
R39	390 1/4W 5%	R1-391	22-1086	R66	10K 1/4W 5%	R1-103	22-1120
R40	220 1/4W 5%	R1-221	22-1080	R67			
R41	390 1/4W 5%	R1-391	22-1086	R68			
R42	220 1/4W 5%	R1-221	22-1080	R69			
R43	390 1/4W 5%	R1-391	22-1086	R70			
R44	220 1/4W 5%	R1-221	22-1080	R71			
R45	390 1/4W 5%	R1-391	22-1086	R72	1000 1/4W 5%	R1-102	22-1096
R46	220 1/4W 5%	R1-221	22-1080	R73	220 1/4W 5%	R1-221	22-1080
				R74	390 1/4W 5%	R1-391	22-1086

600 BOARD PARTS LIST AND DESCRIPTION (CONTINUED)

(When ordering parts, state Model, Part Number, and Description.)

FUSE DEVICES

ITEM No.	DESCRIPTION	REPLACEMENT DATA						
		PART No.		BUSS PART No.		LITTELFUSE PART No.		WORKMAN PART No.
		DEVICE	HOLDER	DEVICE	HOLDER	DEVICE	HOLDER	DEVICE
F1	5A 250V Quick-acting	F-005	HM-FH2	MTH-5	1A1907-02	312005	102068	FG5-2

MISCELLANEOUS

ITEM No.	PART NAME	PART No.	NOTES	
D21	LED (1)			
J1	Connector	SC-40FI	Expansion Connector	
J2	Connector	SC-12FM		
J3	Connector	SC-12FM		
J4	Connector	SC-12FM		
J5	Plug	SC-1MTM	DC Power Video Output Audio Tape Input Audio Tape Output Blower	
J6	Jack			
J7	Jack			
J8	Jack			
M1	Motor			
P9	AC Line Cord			
SW1 thru SW54	Switch			Main Keyboard Shift Lock Break Power 3.932160MHz
X1	Crystal	X-395		

(1) May not be used in Challenger C1P, C1PMF.

WIRING DATA

Shielded Hook-up Wire	Use BELDEN No. 8401 or 8421 (Single-Conductor) 8208 (Two-Conductor)
General-use Unshielded Hook-up Wire	Use BELDEN No. 8528 (Solid) Available in 13 Colors 8522 (Stranded) Available in 13 Colors

610 BOARD PARTS LIST AND DESCRIPTION

(When ordering parts, state Model, Part Number, and Description.)

SEMICONDUCTORS (Select replacement transistor for best results)

ITEM No.	TYPE No.	MFR. PART No.	REPLACEMENT DATA							
			GENERAL ELECTRIC PART No.	MALLORY PART No.	RAYTHEON PART No.	RCA PART No.	SYLVANIA PART No.	THORDARSON PART No.	WORKMAN PART No.	ZENITH PART No.
U1-U3	N8T95N 8T95									
U4	SN7417N 7417							ECC7417	TM7417	
U5	F-7404PC 74LS04		GE-7404				SK7404 SK74LS04	ECC7417 ECC7404 ECC74LS04	TM7417 TM7404 TM74LS04	221-29076
U6	54LS02DM 54LS02									
U7	74LS10PC 74LS10						SK74LS10 SK74LS10	ECC74LS10 ECC74LS10	TM74LS10 TM74LS10	
U8	74LS20PC 74LS20						SK74LS20 SK74LS20	ECC74LS20 ECC74LS20	TM74LS20 TM74LS20	
U9-U11	74LS390PC 74LS390									
U12	74LS93N 74LS93						SK74LS93 SK74LS93	ECC74LS93 ECC74LS93	TM74LS93 TM74LS93	
U13-U14	MC8T28P 8T28									
U15-U18	74S138PC 74LS138						SK74LS138 SK74LS138	ECC74LS93 ECC74LS93	TM74LS93 TM74LS93	
U19-U66	L2114-550									
U67	74LS00N 74LS00						SK74LS00 SK74LS00	ECC74LS00 ECC74LS00	TM74LS00 TM74LS00	
U68	SN74123N 74LS123		GE-74123		REN 74123		SK74123 SK74LS123	ECC74123 ECC74LS123	TM74123 TM74LS123	221-29086
U69	74LS04PC 74LS04						SK74LS04 SK74LS04	ECC74LS04 ECC74LS04	TM74LS04 TM74LS04	
U70	SN74123N 74LS123		GE-74123		REN 74123		SK74123 SK74LS123	ECC74123 ECC74LS123	TM74123 TM74LS123	221-29086
U71	MC6850P 6850									
U72	S6821P 6821									
U73-U75	SN7417N 7417							ECC7417 ECC7417	TM7417 TM7417	

610 BOARD PARTS LIST AND DESCRIPTION (CONTINUED)

(When ordering parts, state Model, Part Number, and Description.)

ELECTROLYTIC CAPACITORS

ITEM No.	RATING	REPLACEMENT DATA				
		MFGR. PART No.	CORNELL-DUBILIER PART No.	MALLORY PART No.	SPRAGUE PART No.	
					Q-LINE	GENERAL LINE
C44	50 25V	C-506	WBR50-25	TT25X50A	QE1-353	TVA-1206
C46	33	C-506	WBR35-50	TT15X30A	QE1-309	TVA-1205.1
	50 25V		WBR50-25	TT25X50A	QE1-353	TVA-1206
	33		WBR35-50	TT15X30A	QE1-309	TVA-1205.1

CAPACITORS

ITEM No.	RATING	MFGR. PART No.	REPLACEMENT DATA			
			CORNELL-DUBILIER PART No.	MALLORY PART No.	SPRAGUE PART No.	
					Q-LINE	GENERAL LINE
C1	.1 10V	CB-10410	MGP1	MAG1201	QC1-223	HY-360
C2	.1 10V	CB-10410	MGP1	MAG1201	QC1-223	HY-360
C3	.1 10V	CB-10410	MGP1	MAG1201	QC1-223	HY-360
C4	.1 10V	CB-10410	MGP1	MAG1201	QC1-223	HY-360
C5	.1 10V	CB-10410	MGP1	MAG1201	QC1-223	HY-360
C6	.1 10V	CB-10410	MGP1	MAG1201	QC1-223	HY-360
C7	.1 10V	CB-10410	MGP1	MAG1201	QC1-223	HY-360
C8	.1 10V	CB-10410	MGP1	MAG1201	QC1-223	HY-360
C9	.1 10V	CB-10410	MGP1	MAG1201	QC1-223	HY-360
C10	.1 10V	CB-10410	MGP1	MAG1201	QC1-223	HY-360
C11	.1 10V	CB-10410	MGP1	MAG1201	QC1-223	HY-360
C12	.1 10V	CB-10410	MGP1	MAG1201	QC1-223	HY-360
C13	.1 10V	CB-10410	MGP1	MAG1201	QC1-223	HY-360
C14	.1 10V	CB-10410	MGP1	MAG1201	QC1-223	HY-360
C15	.1 10V	CB-10410	MGP1	MAG1201	QC1-223	HY-360
C16	.1 10V	CB-10410	MGP1	MAG1201	QC1-223	HY-360
C17	.1 10V	CB-10410	MGP1	MAG1201	QC1-223	HY-360
C18	.1 10V	CB-10410	MGP1	MAG1201	QC1-223	HY-360
C19	.1 10V	CB-10410	MGP1	MAG1201	QC1-223	HY-360
C20	.1 10V	CB-10410	MGP1	MAG1201	QC1-223	HY-360
C21	.1 10V	CB-10410	MGP1	MAG1201	QC1-223	HY-360
C22	.1 10V	CB-10410	MGP1	MAG1201	QC1-223	HY-360
C23	.1 10V	CB-10410	MGP1	MAG1201	QC1-223	HY-360
C24	.1 10V	CB-10410	MGP1	MAG1201	QC1-223	HY-360
C25	.1 10V	CB-10410	MGP1	MAG1201	QC1-223	HY-360
C26	.1 10V	CB-10410	MGP1	MAG1201	QC1-223	HY-360
C27	.1 10V	CB-10410	MGP1	MAG1201	QC1-223	HY-360
C28	.1 10V	CB-10410	MGP1	MAG1201	QC1-223	HY-360
C29	.1 10V	CB-10410	MGP1	MAG1201	QC1-223	HY-360
C30	.1 10V	CB-10410	MGP1	MAG1201	QC1-223	HY-360
C31	.1 10V	CB-10410	MGP1	MAG1201	QC1-223	HY-360
C32	.1 10V	CB-10410	MGP1	MAG1201	QC1-223	HY-360
C33	.1 10V	CB-10410	MGP1	MAG1201	QC1-223	HY-360
C34	.1 10V	CB-10410	MGP1	MAG1201	QC1-223	HY-360
C35	150pF 5%	C-151	CD15FD151J03	SX315	QW1-31	MWA-151
C36	.1 10V	CB-10410	MGP1	MAG1201	QC1-223	HY-360
C37	.001 100V 10%	C-102	DPMS6D1	EWFA210	QF1-1	1PB-D10
C38	150pF 5%	C-151	CD15FD151J03	SX315	QW1-31	MWA-151
C39	.001 100V 10%	C-102	DPMS6D1	EWFA210	QF1-1	1PB-D10
C40	.1 10V	CB-10410	MGP1	MAG1201	QC1-223	HY-360
C41	.1 10V	CB-10410	MGP1	MAG1201	QC1-223	HY-360
C42	.1 10V	CB-10410	MGP1	MAG1201	QC1-223	HY-360
C43	.1 10V	CB-10410	MGP1	MAG1201	QC1-223	HY-360

CONTROLS (All wattages 1/2 watt, or less, unless listed)

ITEM No.	FUNCTION	RESISTANCE	REPLACEMENT DATA		
			MFGR. PART No.	MALLORY PART No.	TRW PART No.
R9	TX Data	10K	RP-103		
R10	RX Clock	10K	RP-103		
R18	TX Clock	10K	RP-103		
R19	RX Data	10K	RP-103		

RESISTORS

ITEM No.	RATING	REPLACEMENT DATA		ITEM No.	RATING	REPLACEMENT DATA	
		MFGR. PART No.	WORKMAN PART No.			MFGR. PART No.	WORKMAN PART No.
R1	220 1/4W 5%	R1-221	22-1080	R26	390 1/4W 5%	R1-391	22-1086
R2	220 1/4W 5%	R1-221	22-1080	R27	220 1/4W 5%	R1-221	22-1080
R3	220 1/4W 5%	R1-221	22-1080	R28	390 1/4W 5%	R1-391	22-1086
R4	390 1/4W 5%	R1-391	22-1086	R29	220 1/4W 5%	R1-221	22-1080
R5	390 1/4W 5%	R1-391	22-1086	R30	390 1/4W 5%	R1-391	22-1086
R6	390 1/4W 5%	R1-391	22-1086	R31	220 1/4W 5%	R1-221	22-1080
R8	1000 1/4W 5%	R1-102	22-1096	R32	390 1/4W 5%	R1-391	22-1086
R11	220 1/4W 5%	R1-221	22-1080	R33	220 1/4W 5%	R1-221	22-1080
R12	390 1/4W 5%	R1-391	22-1086	R34	390 1/4W 5%	R1-391	22-1086
R13	1000 1/4W 5%	R1-102	22-1096	R35	470 1/4W 5%	R1-471	22-1088
R14	1000 1/4W 5%	R1-102	22-1096	R36	470 1/4W 5%	R1-471	22-1088
R15	1000 1/4W 5%	R1-102	22-1096	R37	470 1/4W 5%	R1-471	22-1088
R16	220 1/4W 5%	R1-221	22-1080	R38	470 1/4W 5%	R1-471	22-1088
R17	390 1/4W 5%	R1-391	22-1086	R39	470 1/4W 5%	R1-471	22-1088
R20	18K 1/4W 5%	R1-183	22-1126	R40	470 1/4W 5%	R1-471	22-1088
R21	220 1/4W 5%	R1-221	22-1080	R41	470 1/4W 5%	R1-471	22-1088
R22	390 1/4W 5%	R1-391	22-1086	R42	4700 1/4W 5%	R1-472	22-1112
R23	220 1/4W 5%	R1-221	22-1080	R43	470 1/4W 5%	R1-471	22-1088
R24	390 1/4W 5%	R1-391	22-1086	R44	470 1/4W 5%	R1-471	22-1088
R25	220 1/4W 5%	R1-221	22-1080	R45	470 1/4W 5%	R1-471	22-1088

610 BOARD PARTS LIST AND DESCRIPTION (CONTINUED)

(When ordering parts, state Model, Part Number, and Description.)

MISCELLANEOUS

ITEM No.	PART NAME	PART No.	NOTES
J1	Socket	SC-40FI	
J2	Socket	SC-40FI	
J3	Plug	SC-12MM	(2 used)
J4	Connector	SC-1MTM	2 Pin DC
	IC Socket	SC-14FI	14 Pin
	IC Socket	SC-16FI	16 Pin
	IC Socket	SC-18FI	18 Pin
	IC Socket	SC-24FI	24 Pin
	IC Socket	SC-40FI	40 Pin

WIRING DATA

Shielded Hook-up Wire	Use BELDEN No. 8401 or 8421 (Single-Conductor) 8208 (Two-Conductor)
General-use Unshielded Hook-up Wire	Use BELDEN No. 8528 (Solid) Available in 13 Colors 8522 (Stranded) Available in 13 Colors

Waveform 1

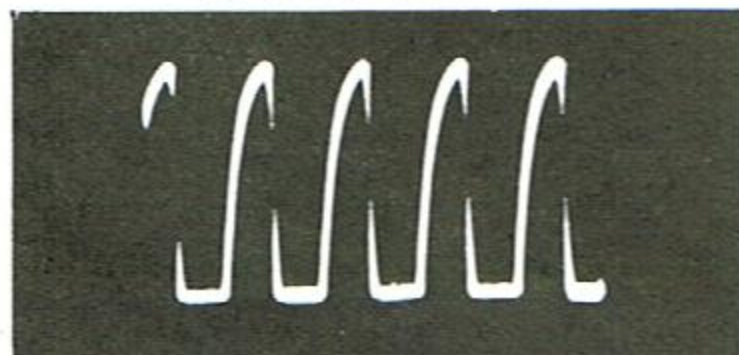

0.5 μ Sec 4.0V

Waveform 2

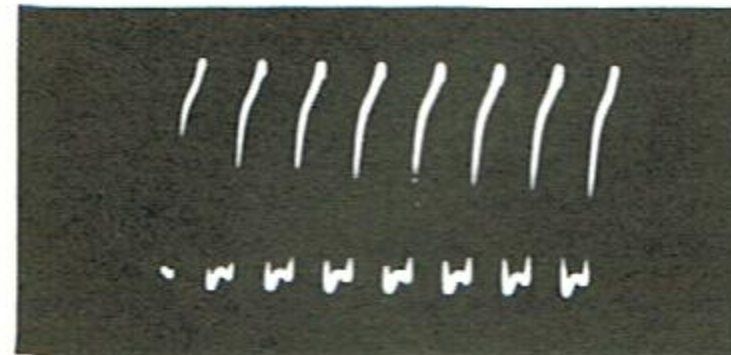

0.2 μ Sec 3.0V

Waveform 3

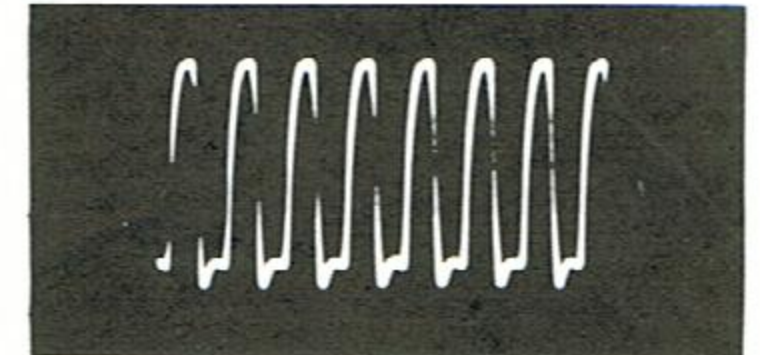

0.2 μ Sec 4.0V

Waveform 4

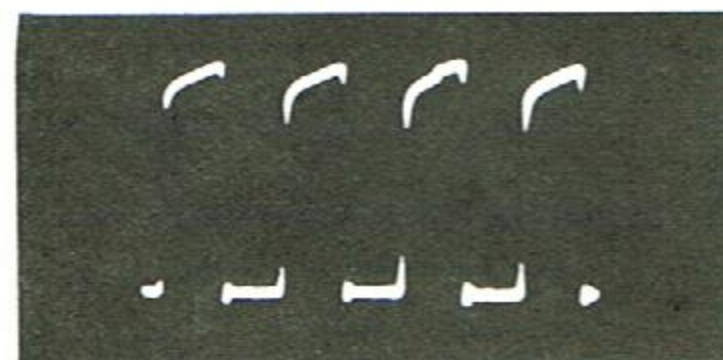

0.2 μ Sec 4.0V

Waveform 5

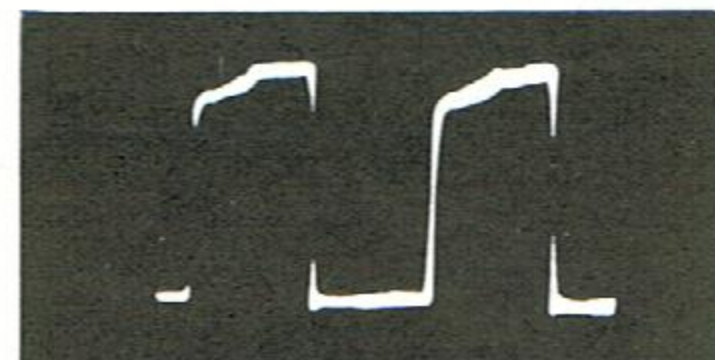

0.2 μ Sec 4.0V

Waveform 6

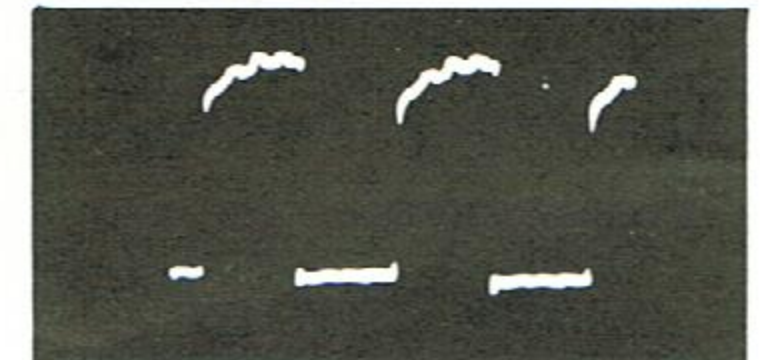

0.5 μ Sec 4.0V

Waveform 7

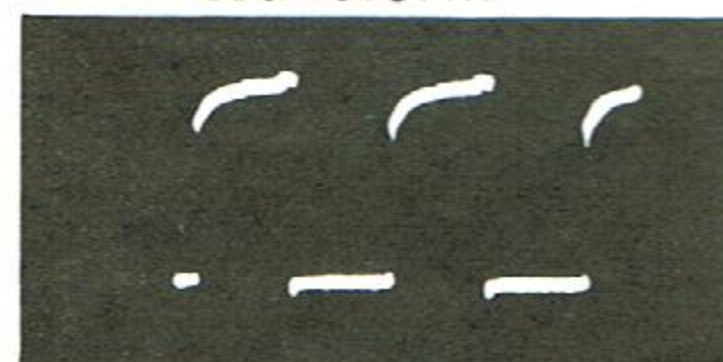

1 μ Sec 4.0V

Waveform 8

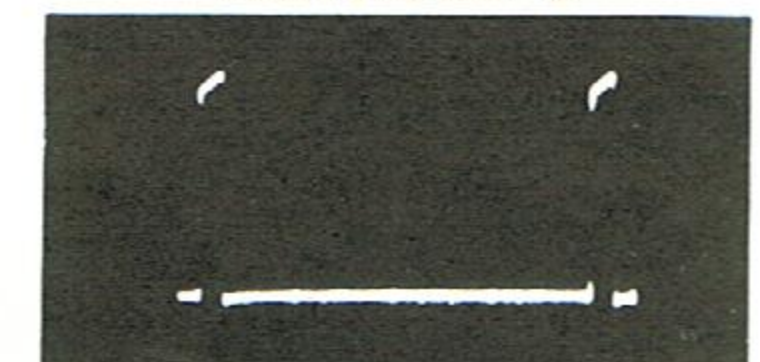

0.5 μ Sec 4.0V

WAVEFORMS TAKEN IN "BASIC" MODE UNLESS OTHERWISE INDICATED

KEYBOARD

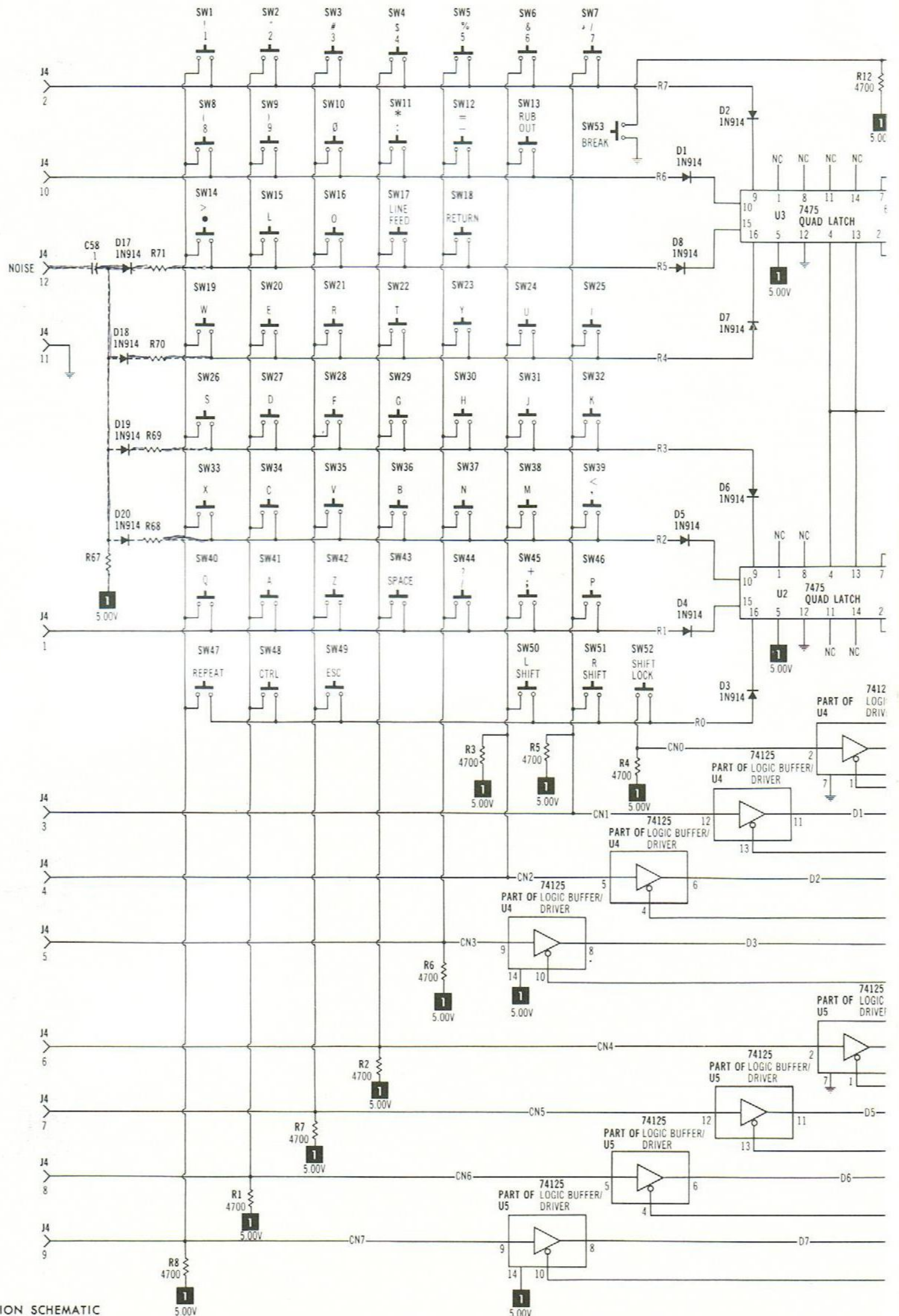

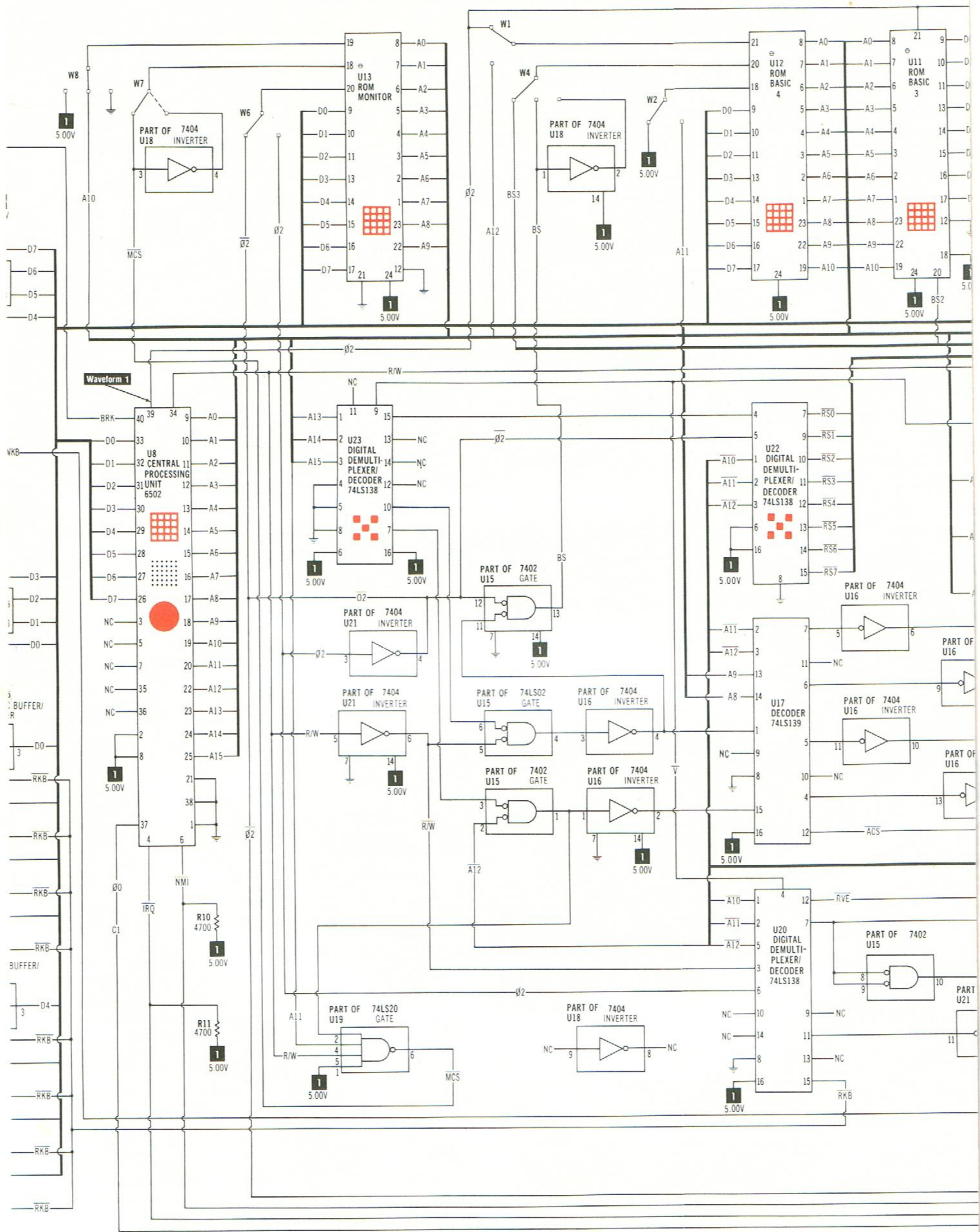

FOR COLOR KEYED TROUBLESHOOTING SEE PAGES 1, 2 & 3

FOR SCHEMATIC LEGEND

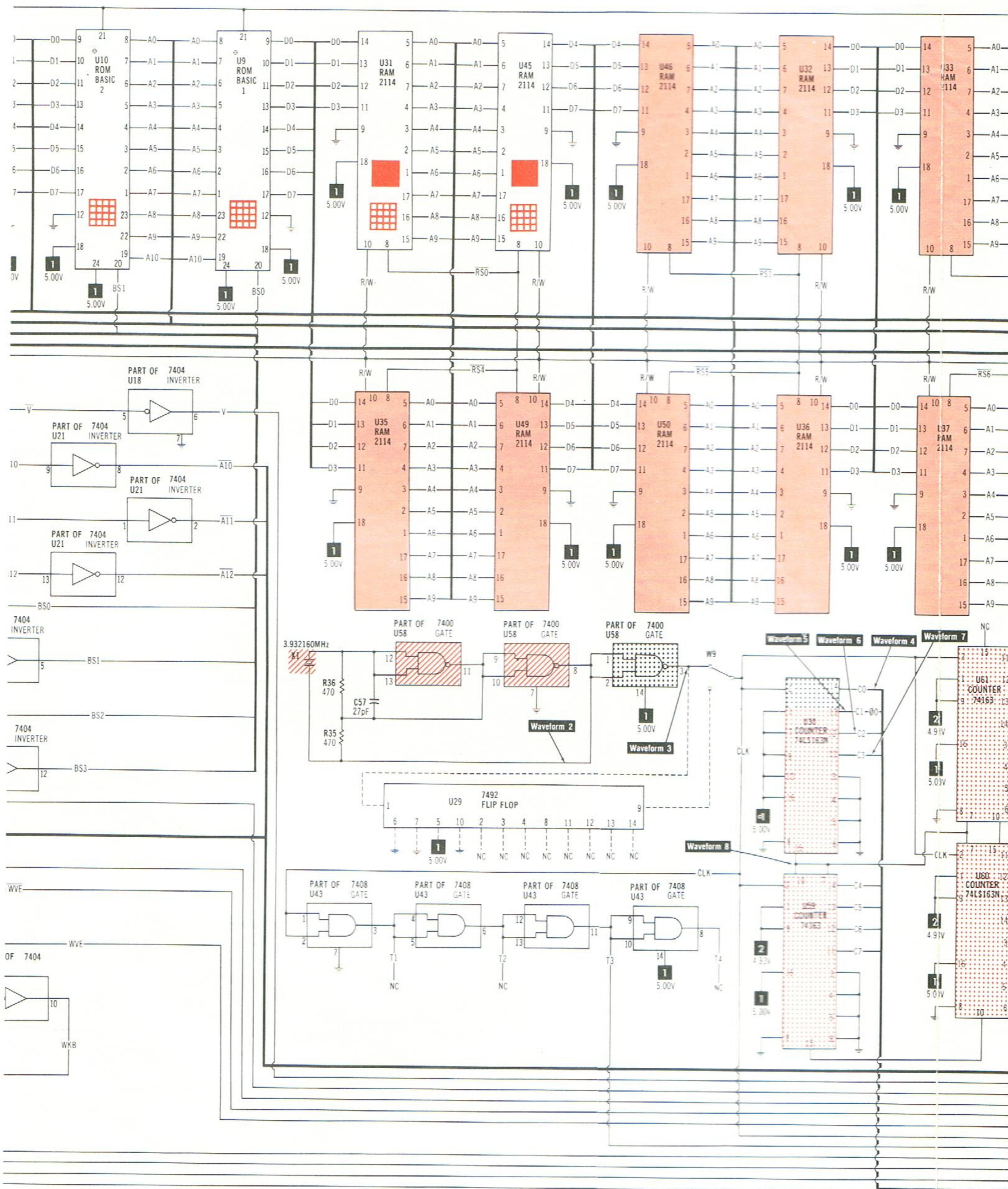

SEND AND NOTES SEE INSIDE REAR COVER

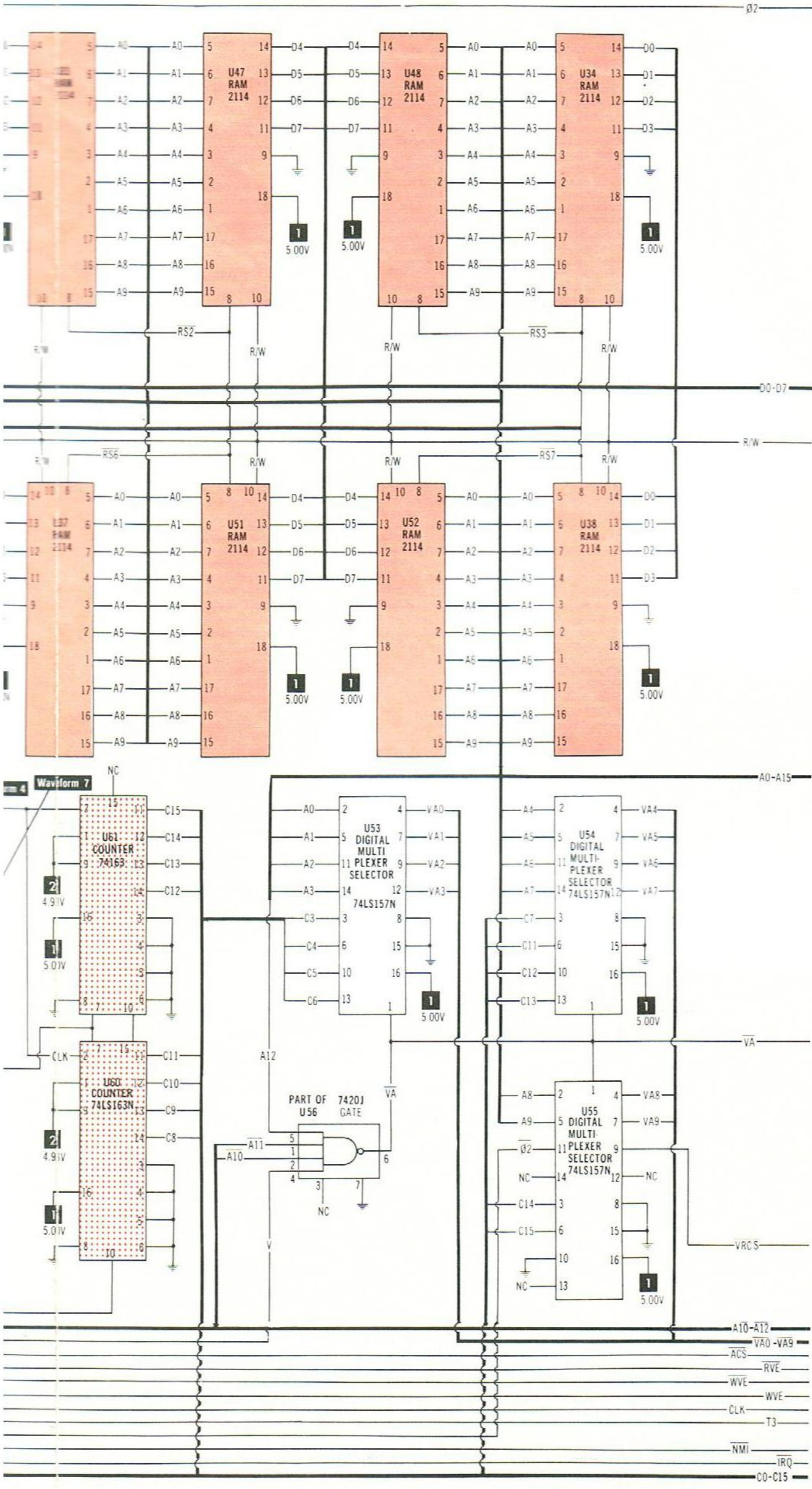

SUPERBOARD II/600 BOARD

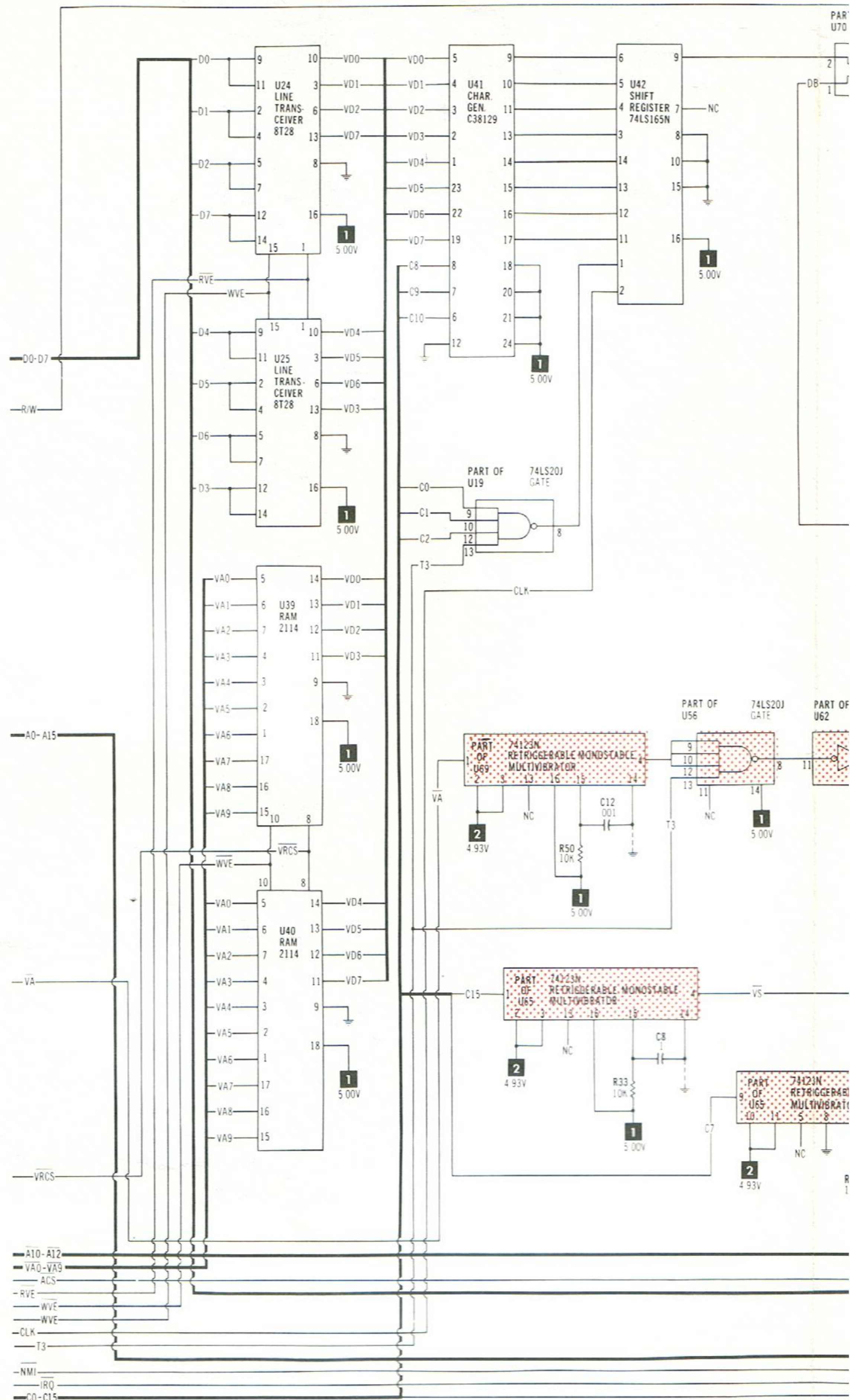

for
CO
Ch
SUP
MOI
MOI

A PHOTOFAC STANDARD NOTATION SCHEMATIC
WITH **CIRCUITRACE**
© Howard W. Sams & Co., Inc. 1979

SUPERBOARD II/600 BOARD

FOR COL

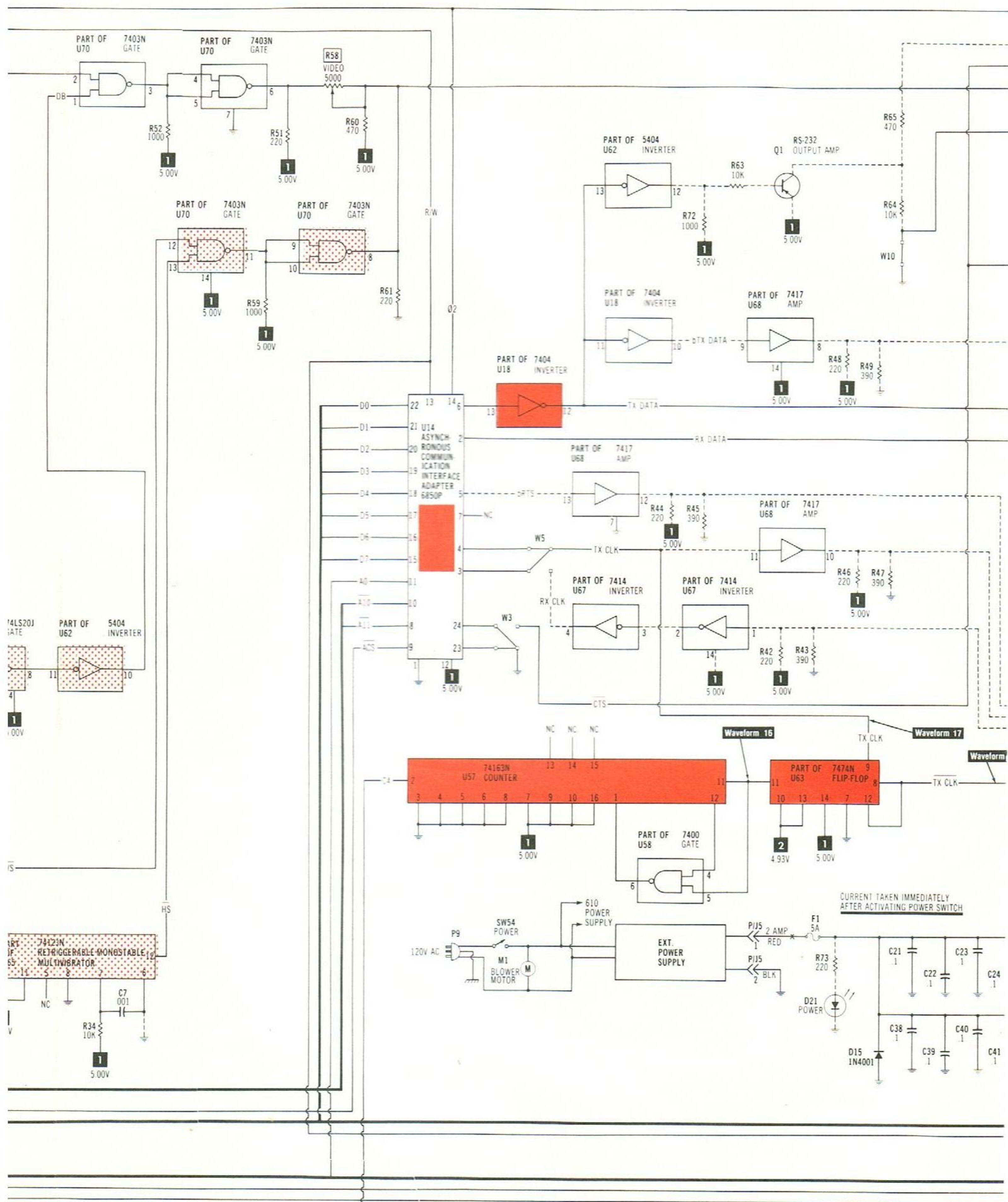

OR COLOR KEYED TROUBLESHOOTING SEE PAGES 1, 2 & 3 FOR SCHEMATIC LEGEND A

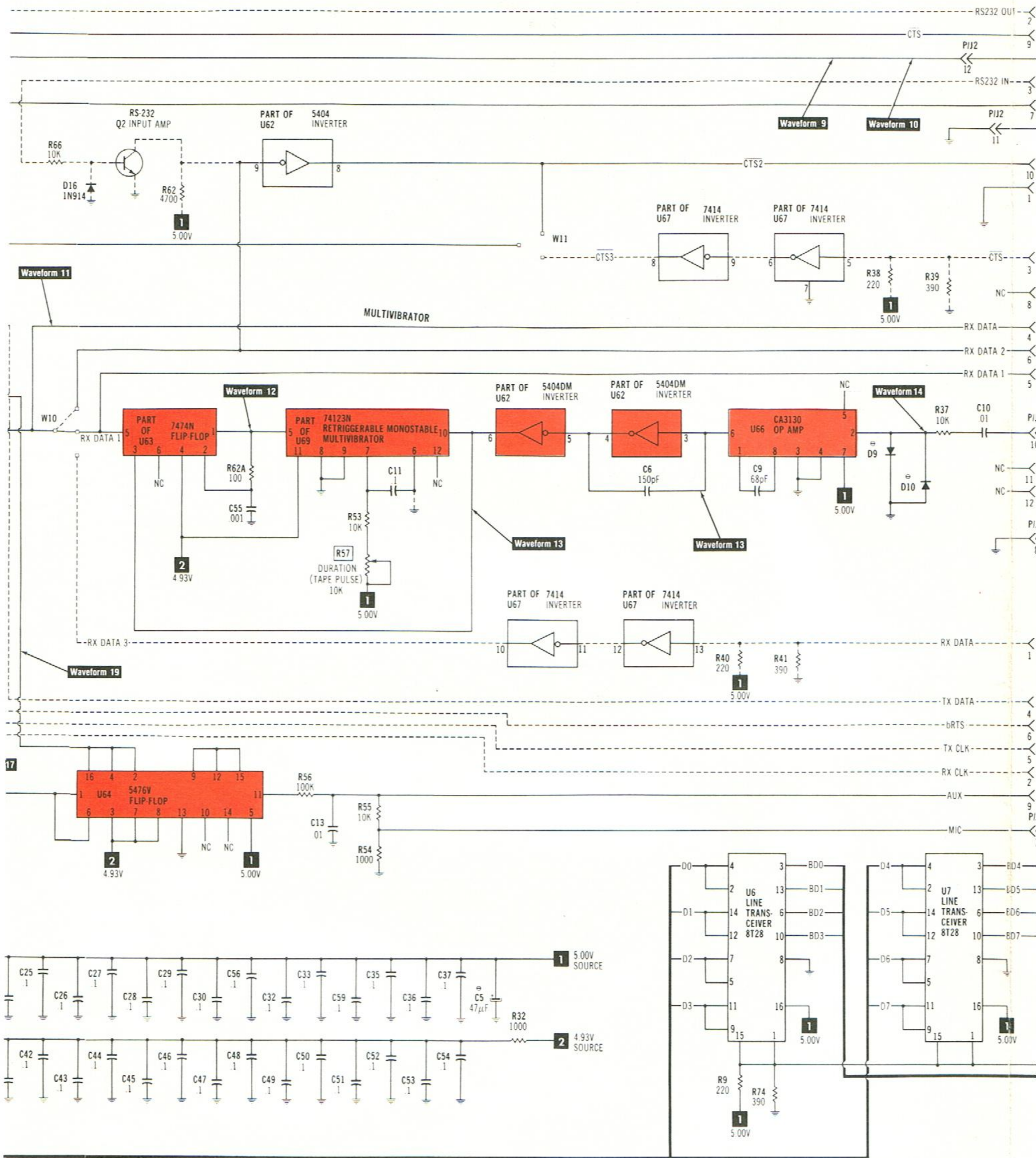

ND NOTES SEE INSIDE REAR COVER

SUPERBOARD II/600 BOARD

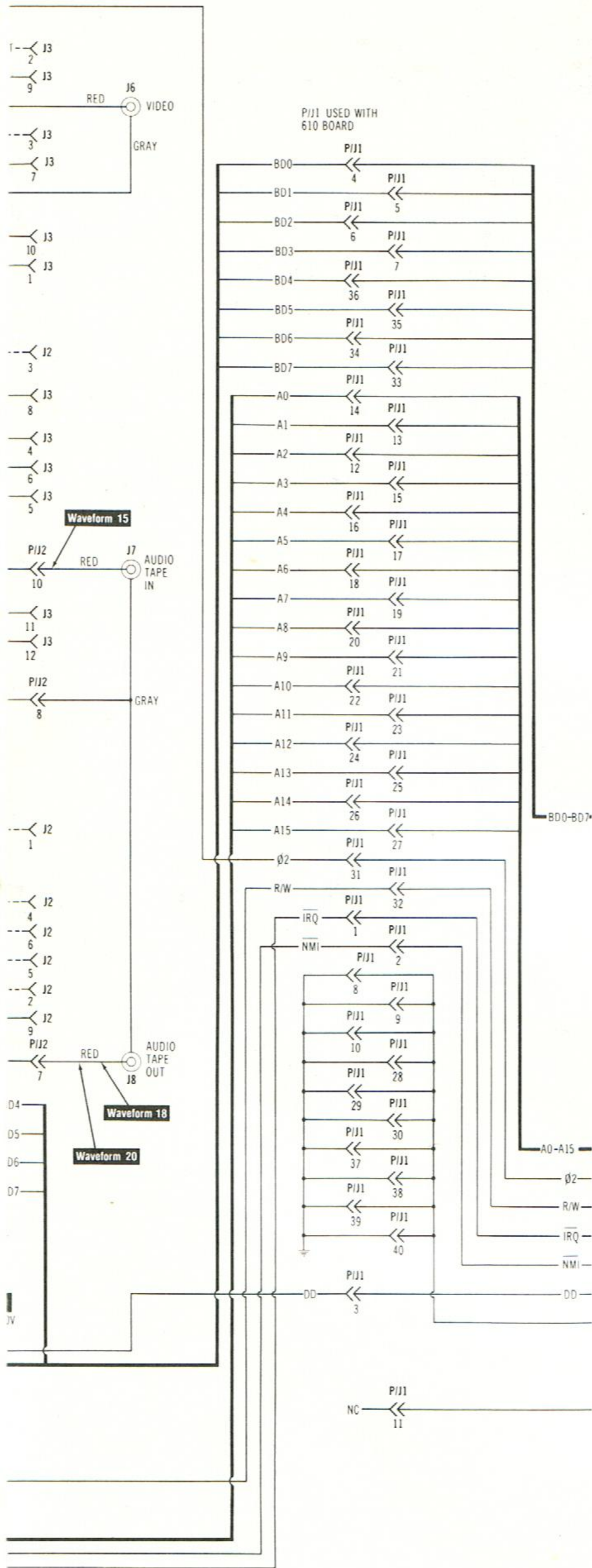

Waveform 9

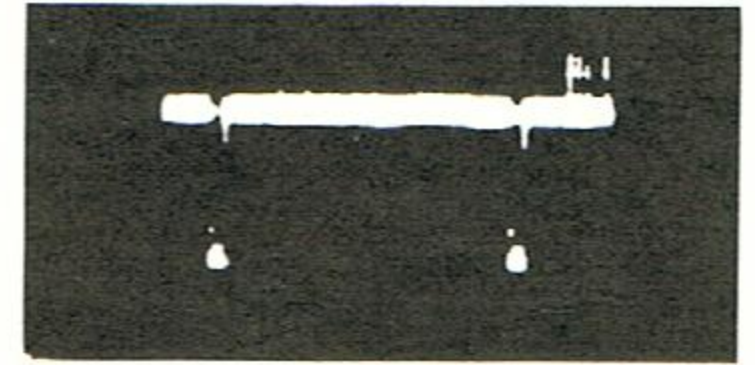

10 μ Sec 2.0V

Waveform 10

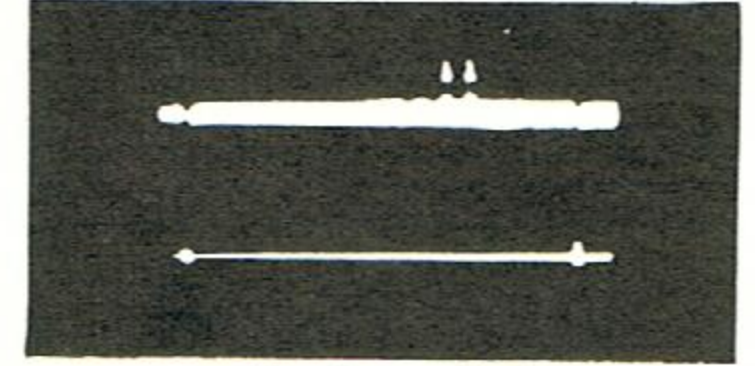

2mSec 2.0V

Waveform 11



5mSec 4.2V
Program transferred from tape

Waveform 12



0.2mSec 4.2V
Program transferred from tape

Waveform 13

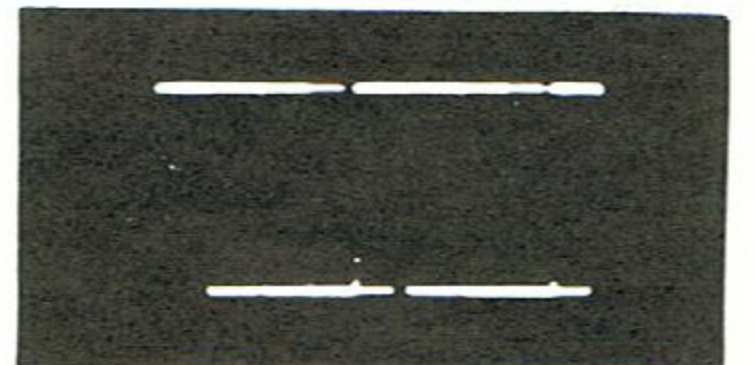

0.2mSec 4.4V
Program transferred from tape

Waveform 14

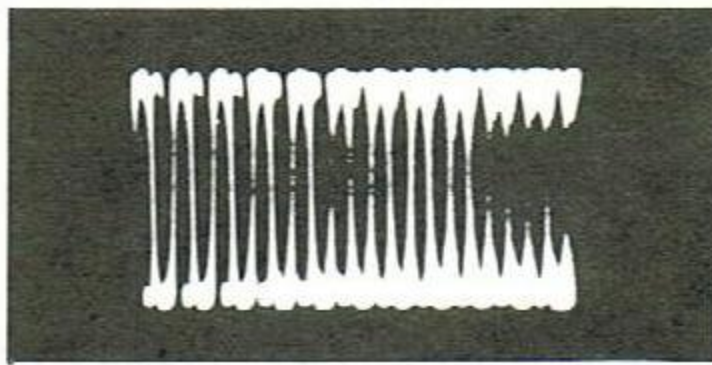

1mSec 1.1V
Program transferred from tape

Waveform 15

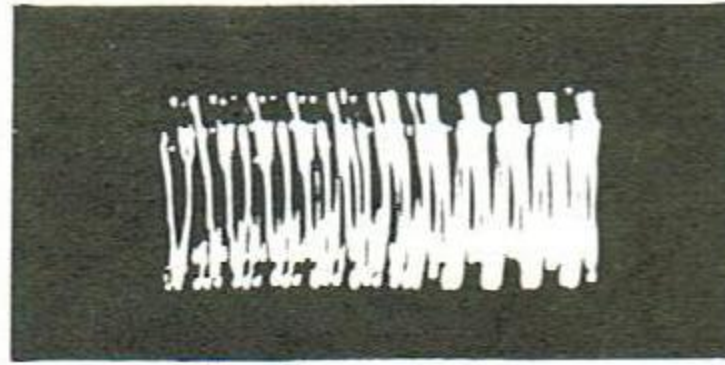

1mSec 5.0V
Amplitude dependant on tape volume
Program transferred from tape

Waveform 16

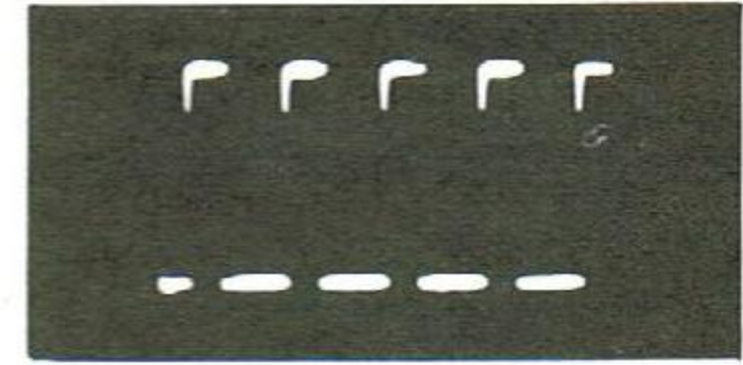

50μSec 4.0V

Waveform 17

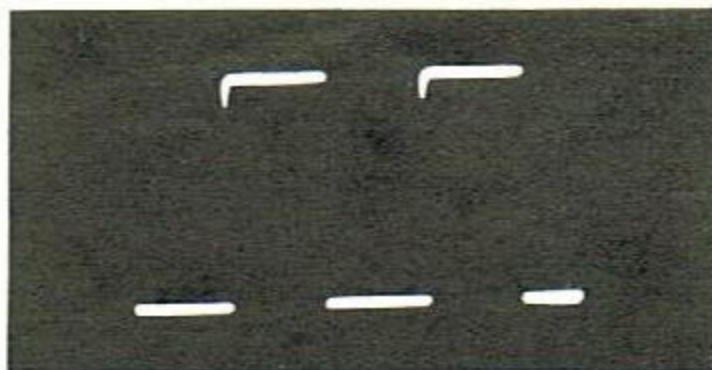

50μSec 4.0V

Waveform 18

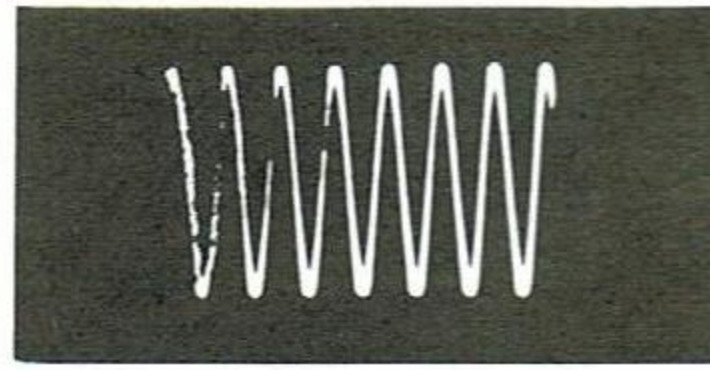

0.5mSec 30mV
Tape mode prior to program storage

Waveform 19



5mSec 4.2V
Program transferred to tape

Waveform 20

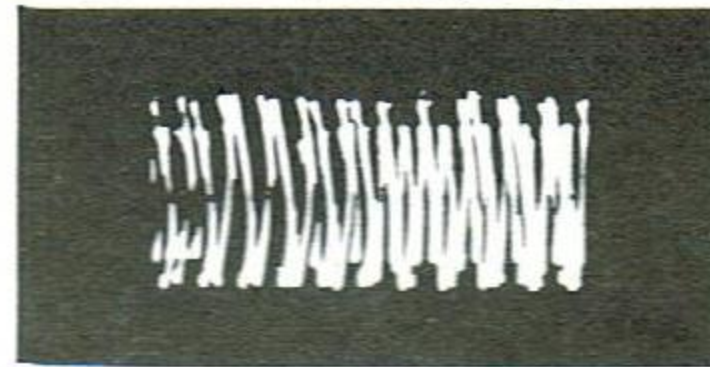

1mSec 30mV
Program transferred to tape

**WAVEFORMS TAKEN IN "BASIC" MODE UNLESS OTHERWISE INDICATED
ELECTRICAL ADJUSTMENT**

R57 DURATION (TAPE PULSE)

Connect jumper between pin 9 and 10 of J2.

Press	"RESET"	
Press	"C"	
Press	"RETURN"	
Press	"RETURN"	
Type	10 PRINT "U";	Return
Type	20 GO TO 10	Return
Type	SAVE	Return
Type	RUN	Return

Input of scope to pin 5 of U69. Adjust R57 for a positive pulse width of at least 500 μ seconds but not over 640 μ seconds. Disconnect jumper.

R58 VIDEO (MONITOR)

Place computer into basic and type in a full monitor of characters. Adjust R58 for best contrast but do not allow unit to lose sync.

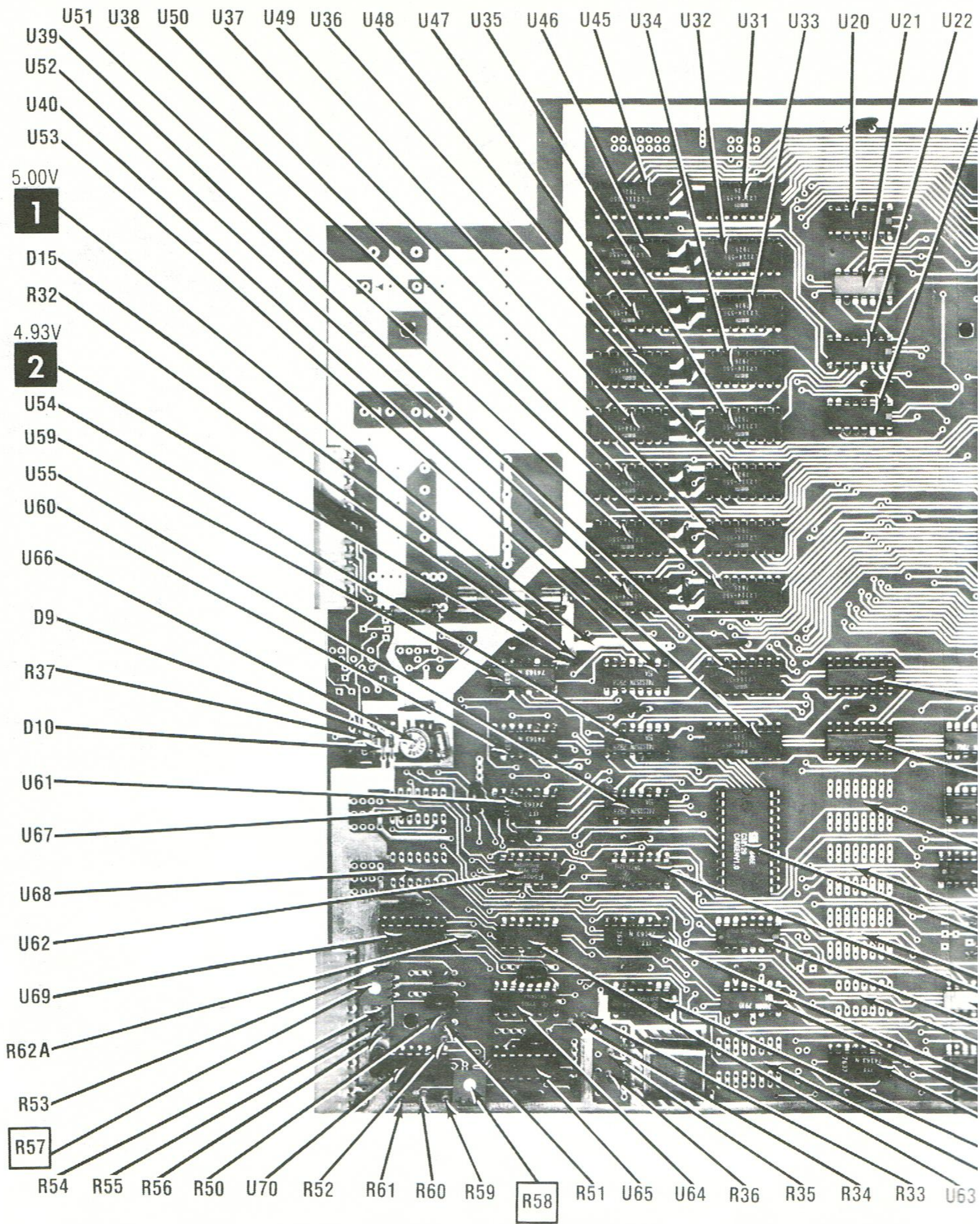

SUPERBOARD II/600 BOARD

A Howard W. Sams **CIRCUITRACE** Photo

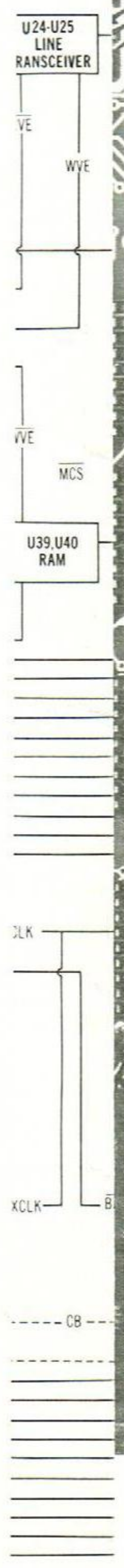
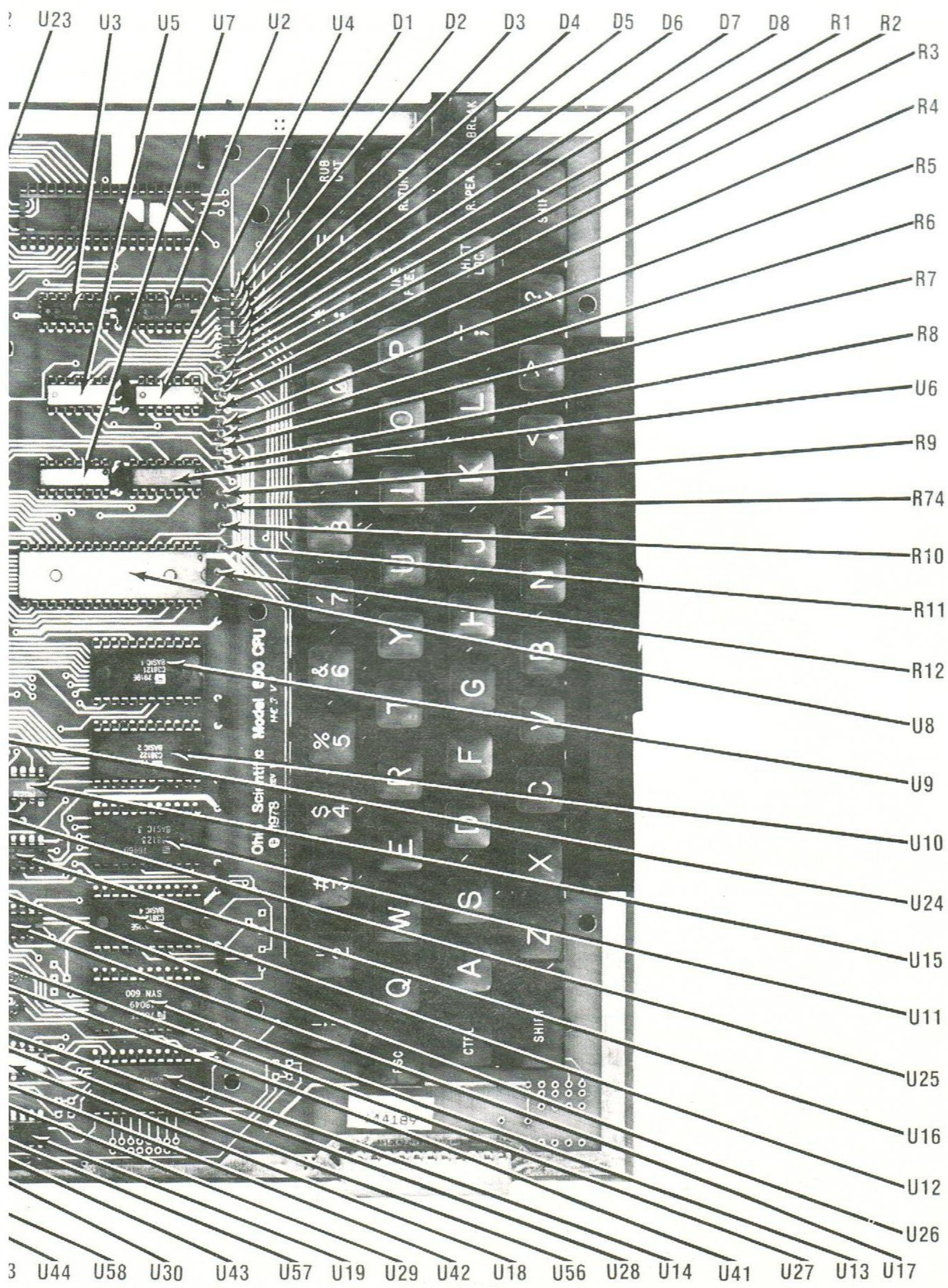

SUPERBOARD II/600 BOARD

SUPERBOARD II/600 BOARD PINOUTS

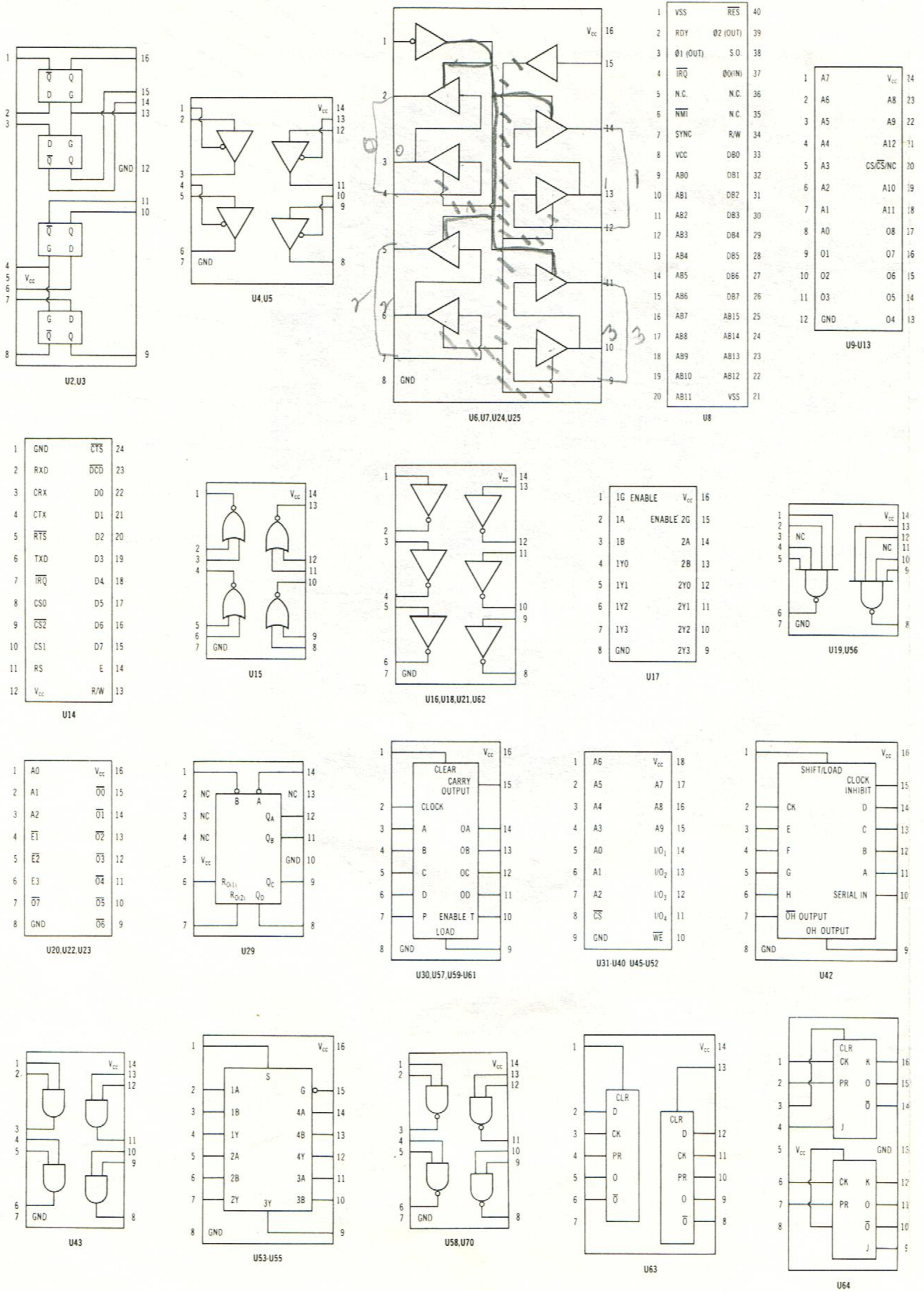

PINOUTS CONTINUED ON PAGE 34

24
23
22
21
20
9
8
7
6
5
4
3

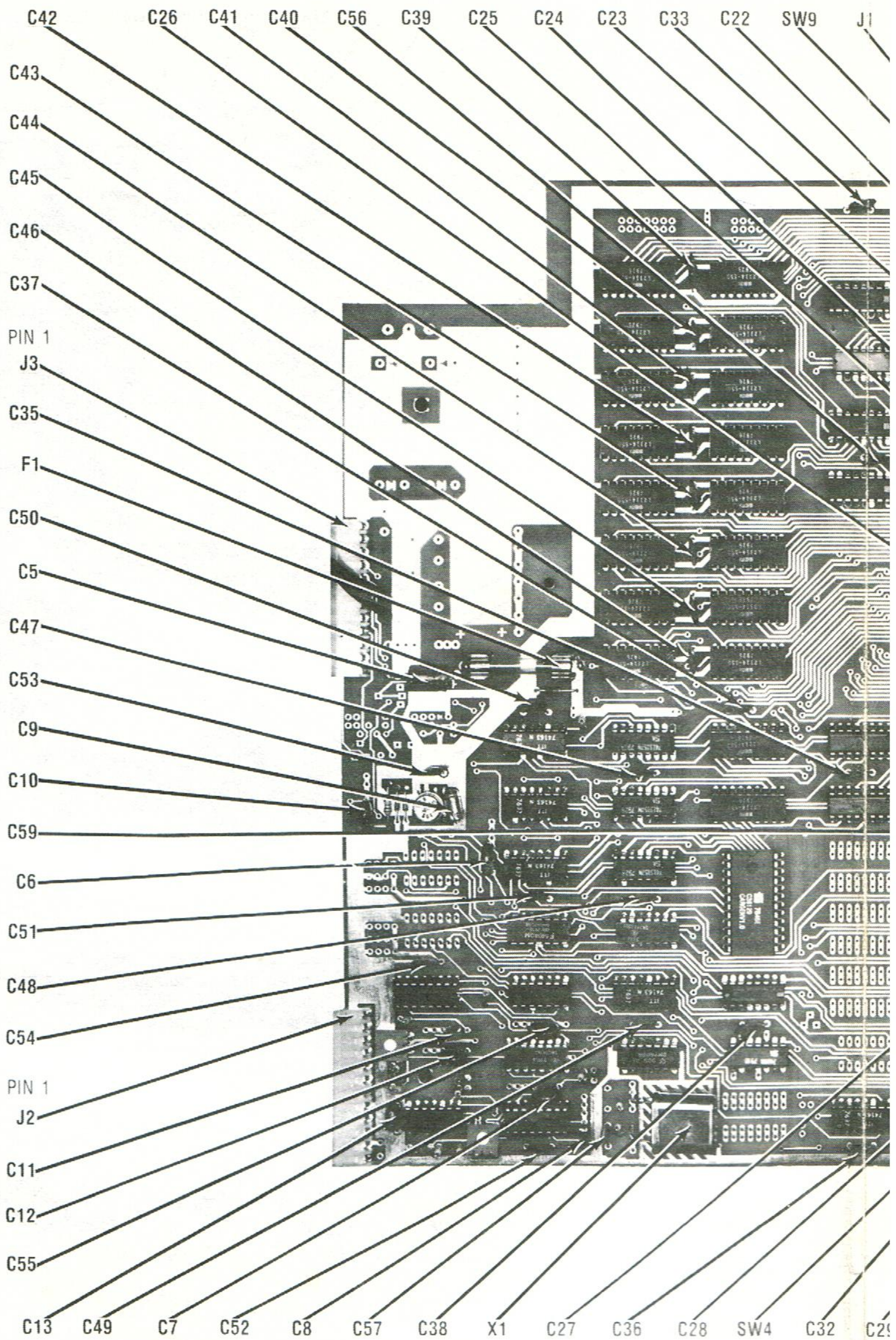

SUPERBOARD II/600 BOARD

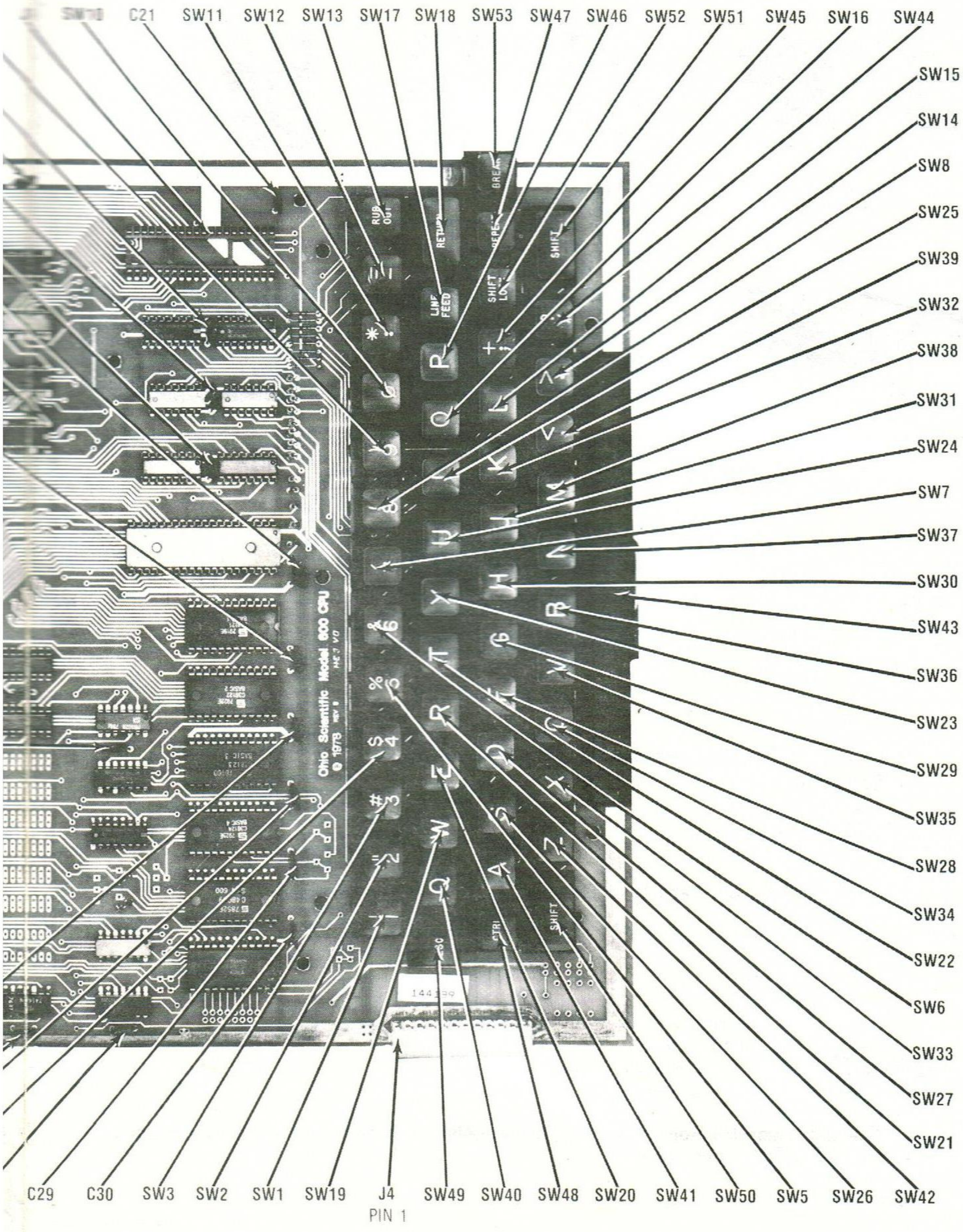

SUPERBOARD II/600 BOARD

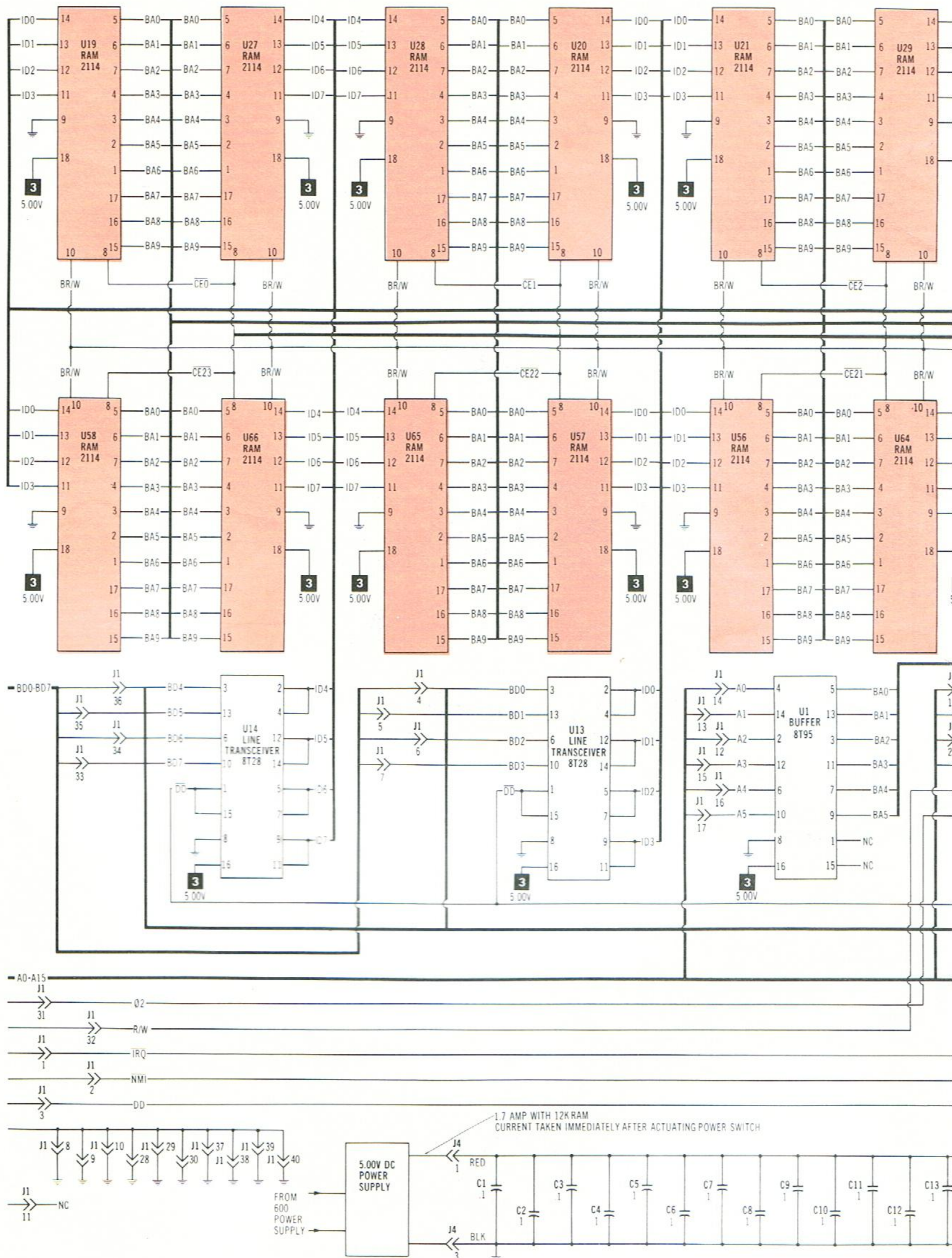

A PHOTOFACIT STANDARD NOTATION SCHEMATIC
 WITH **CIRCUITRACE**[®]
 © Howard W. Sams & Co., Inc. 1979

610 BOARD

FOR COLOR KEYED TROUBLESHOOTING

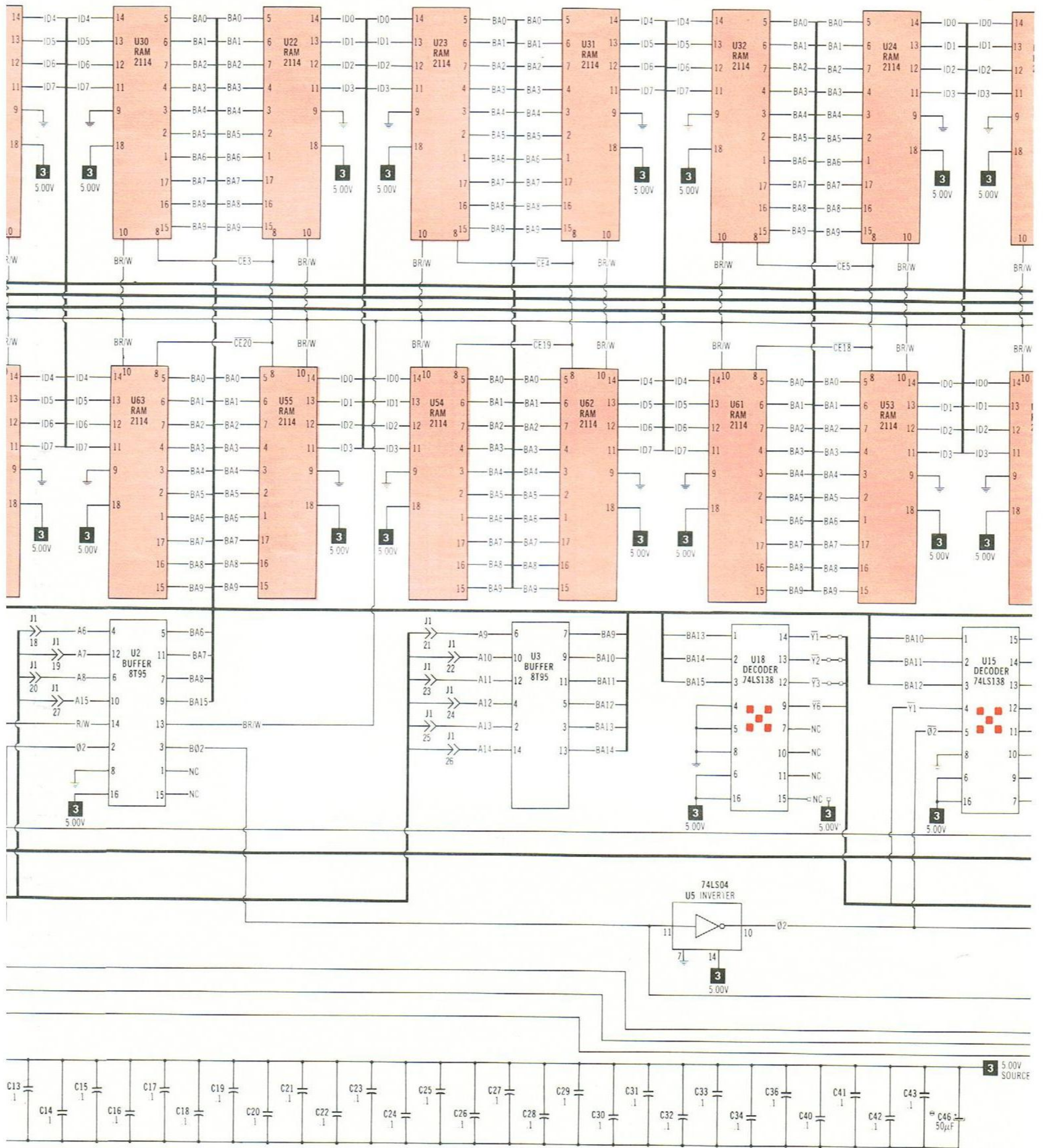

ING SEE PAGES 1, 2 & 3

FOR SCHEMATIC LEGEND AND NOTES SEE INSIDE REAR COVER

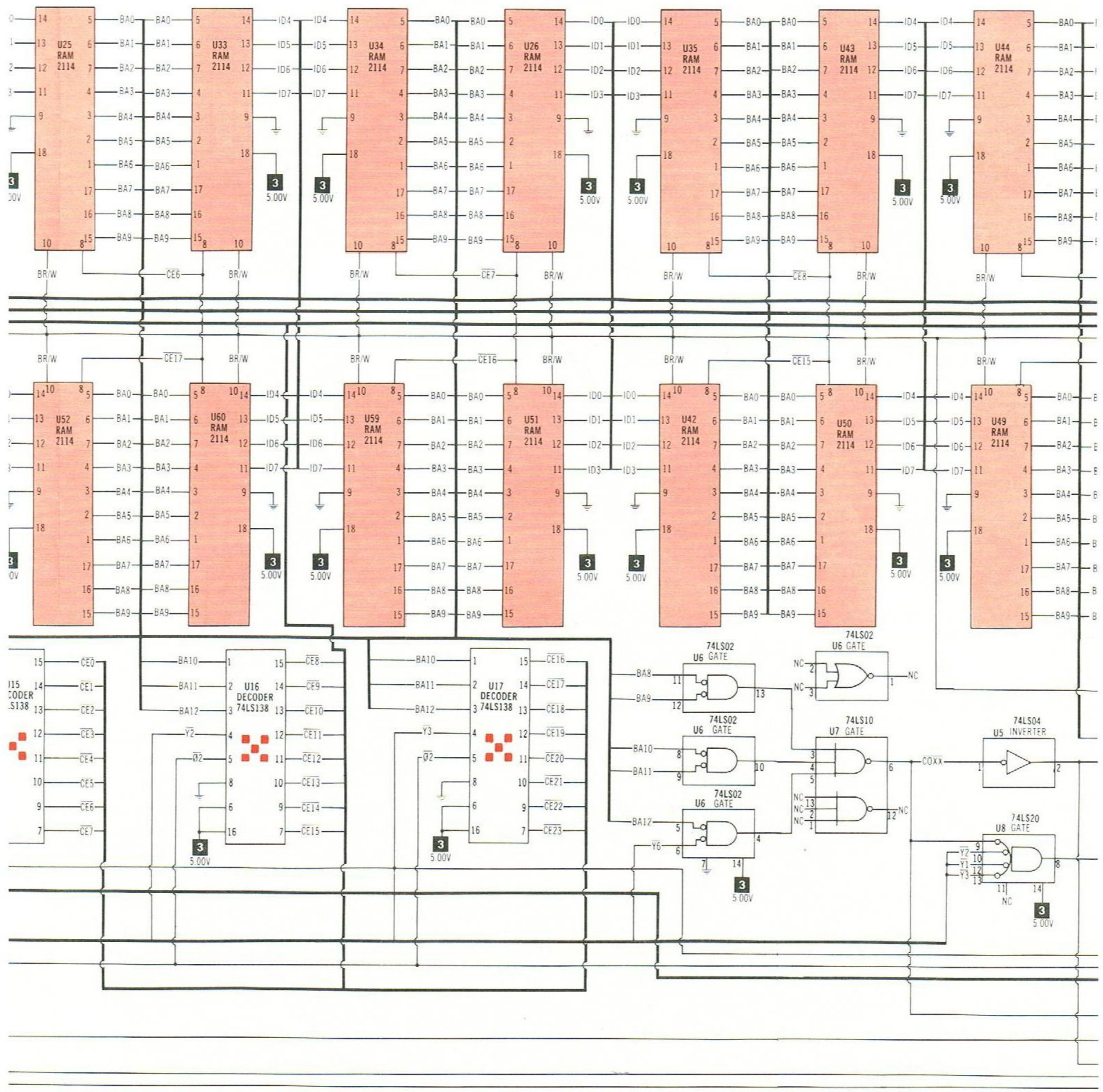

3 5.00V SOURCE

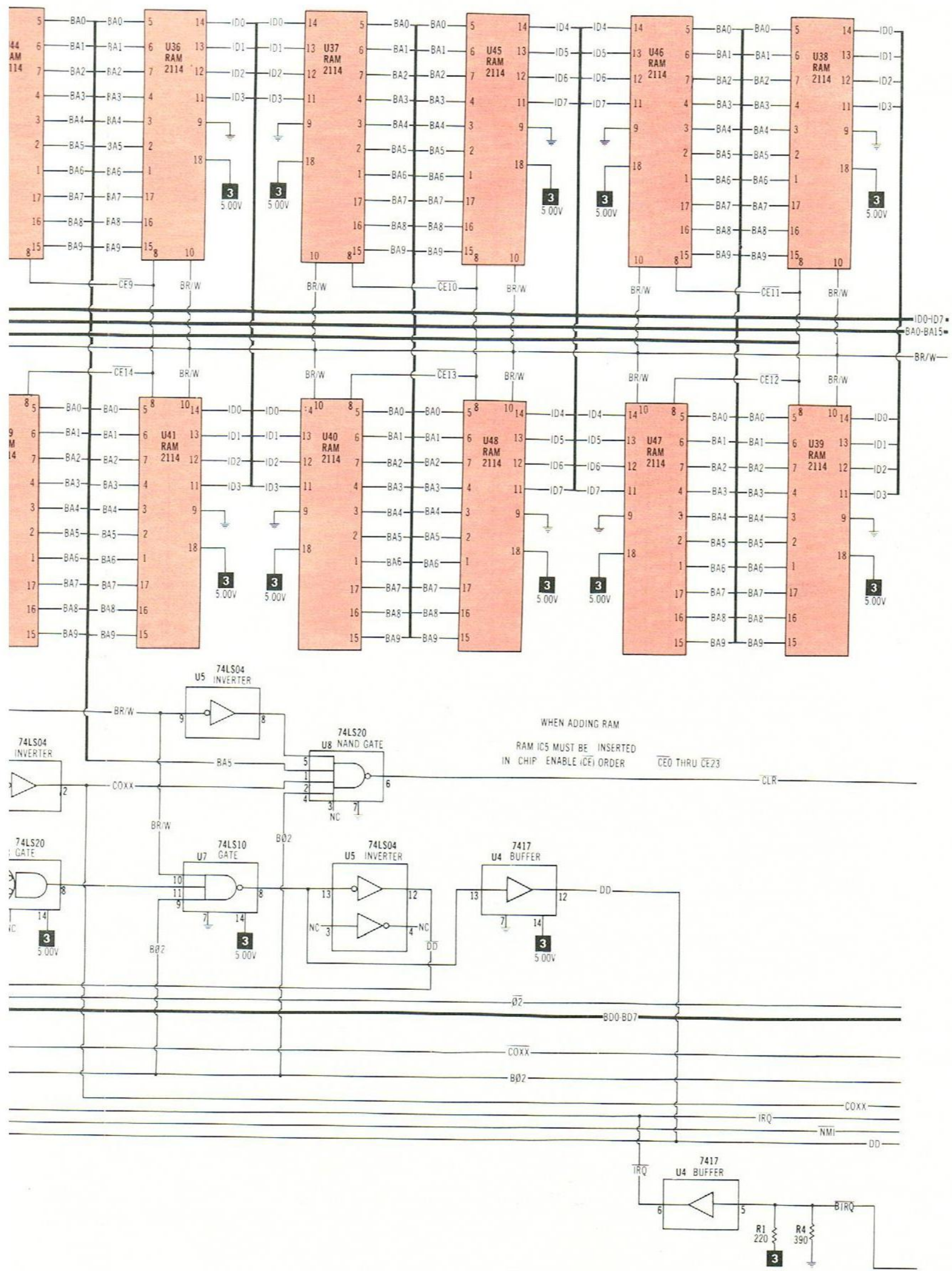

610 BOARD

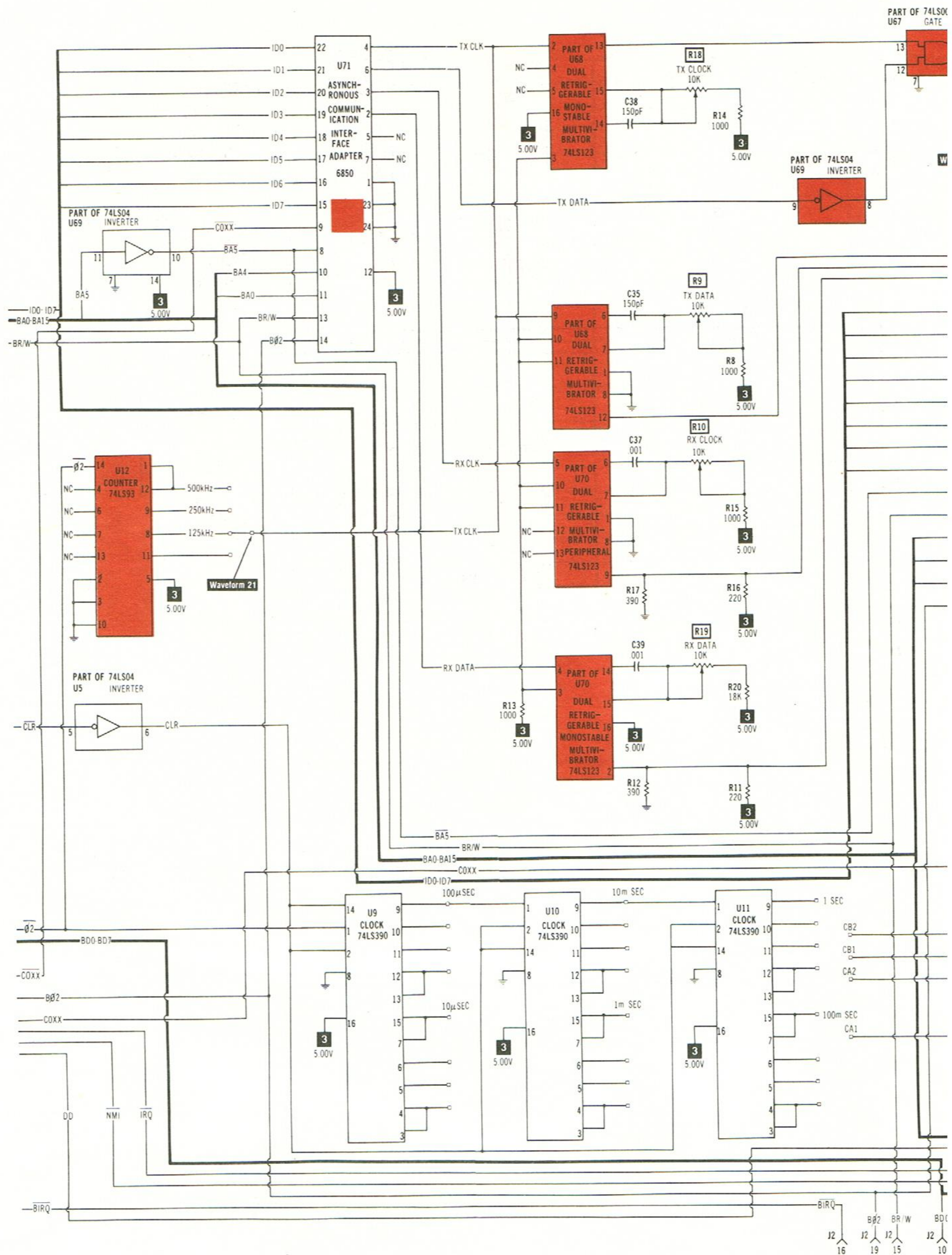

A PHOTOFACIT STANDARD NOTATION SCHEMATIC
 WITH **CIRCUITRACE**[®]
 © Howard W. Sams & Co., Inc. 1979

610 BOARD

FOR SCHEMATIC LEGEND AND NOTES S
 FOR COLOR KEYED TROUBLESHOOTING

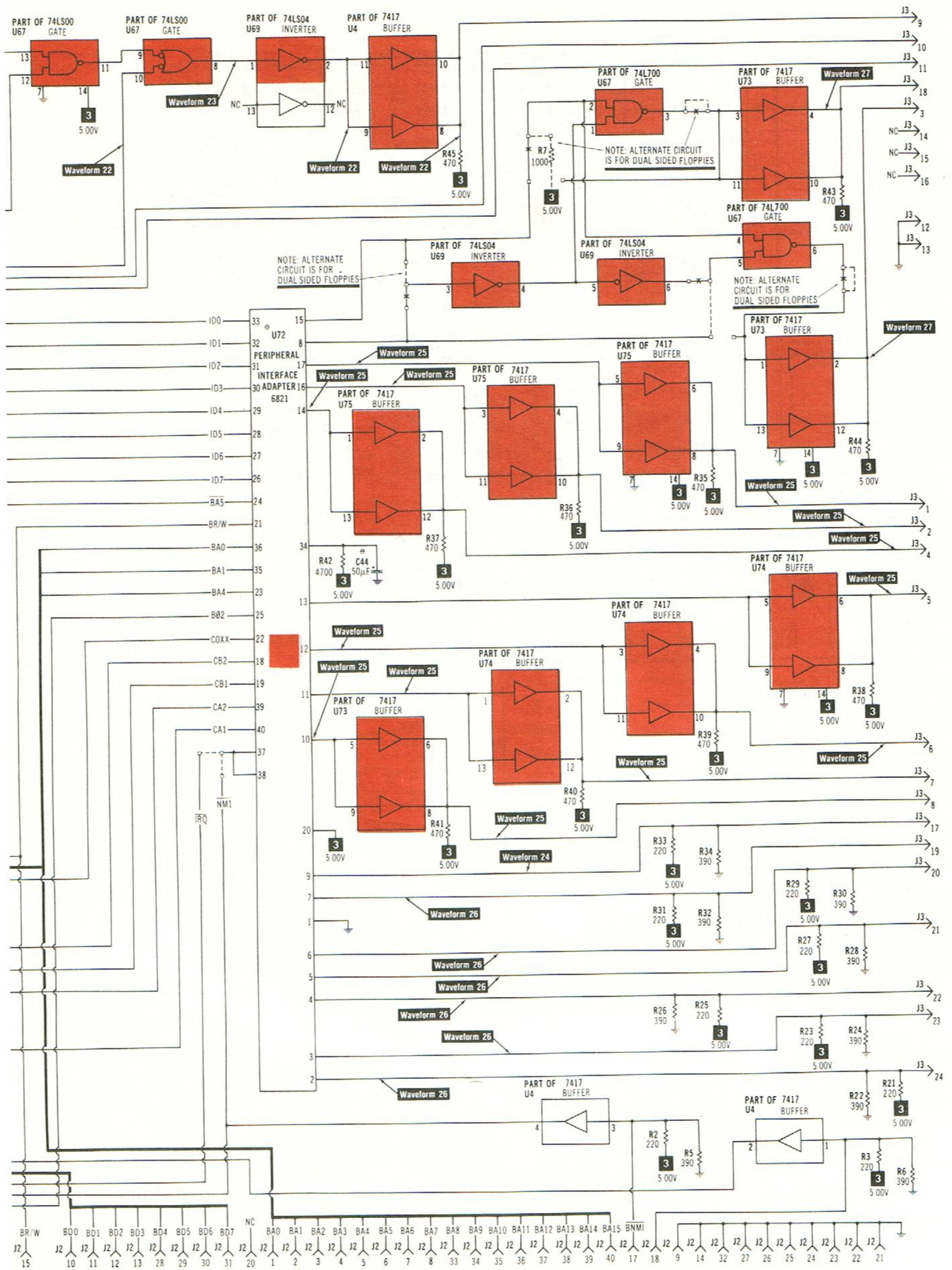

WAVEFORMS SEE INSIDE REAR COVER
 CONNECTIONS SEE PAGES 1, 2 & 3

610 BOARD

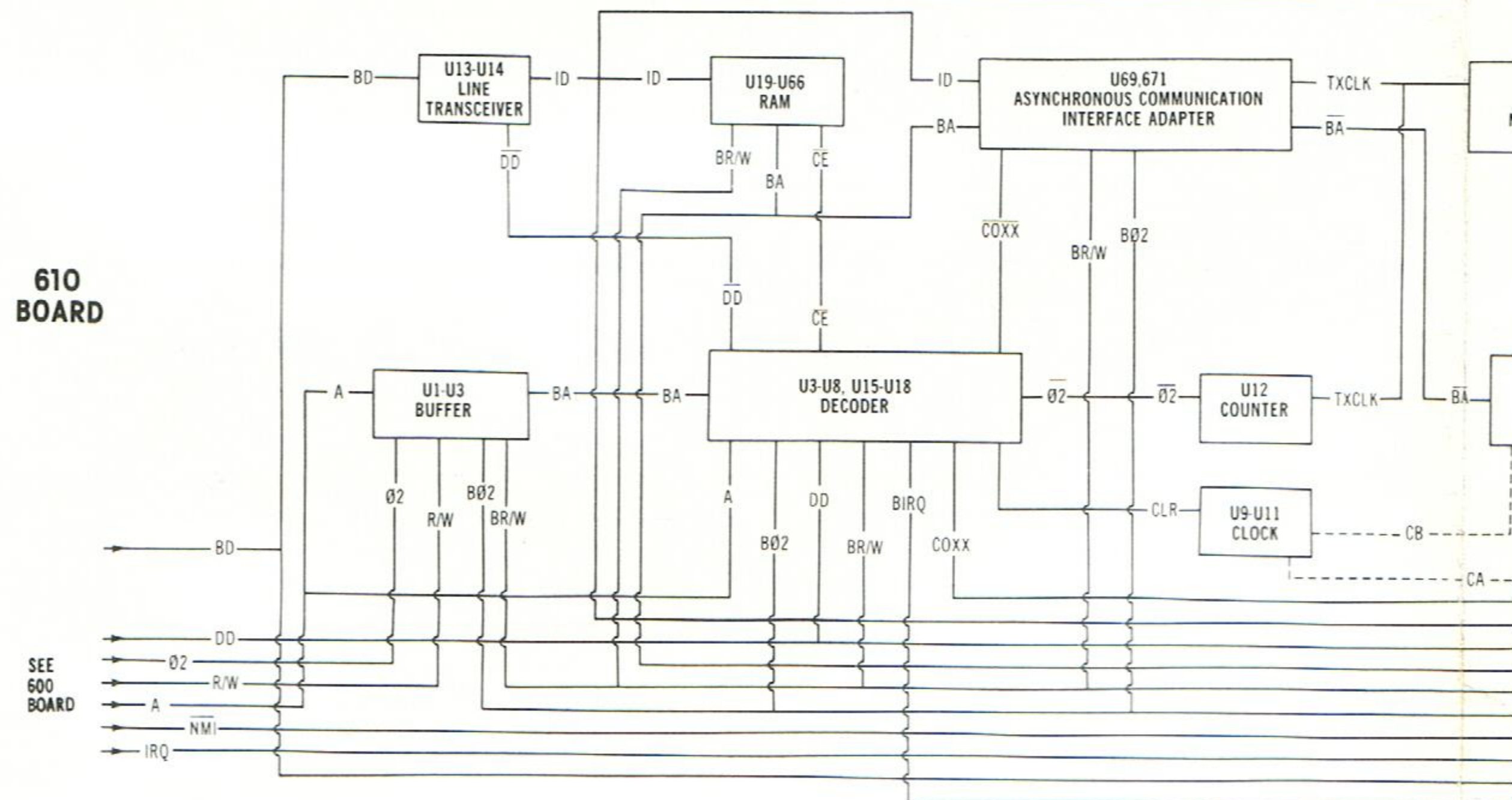
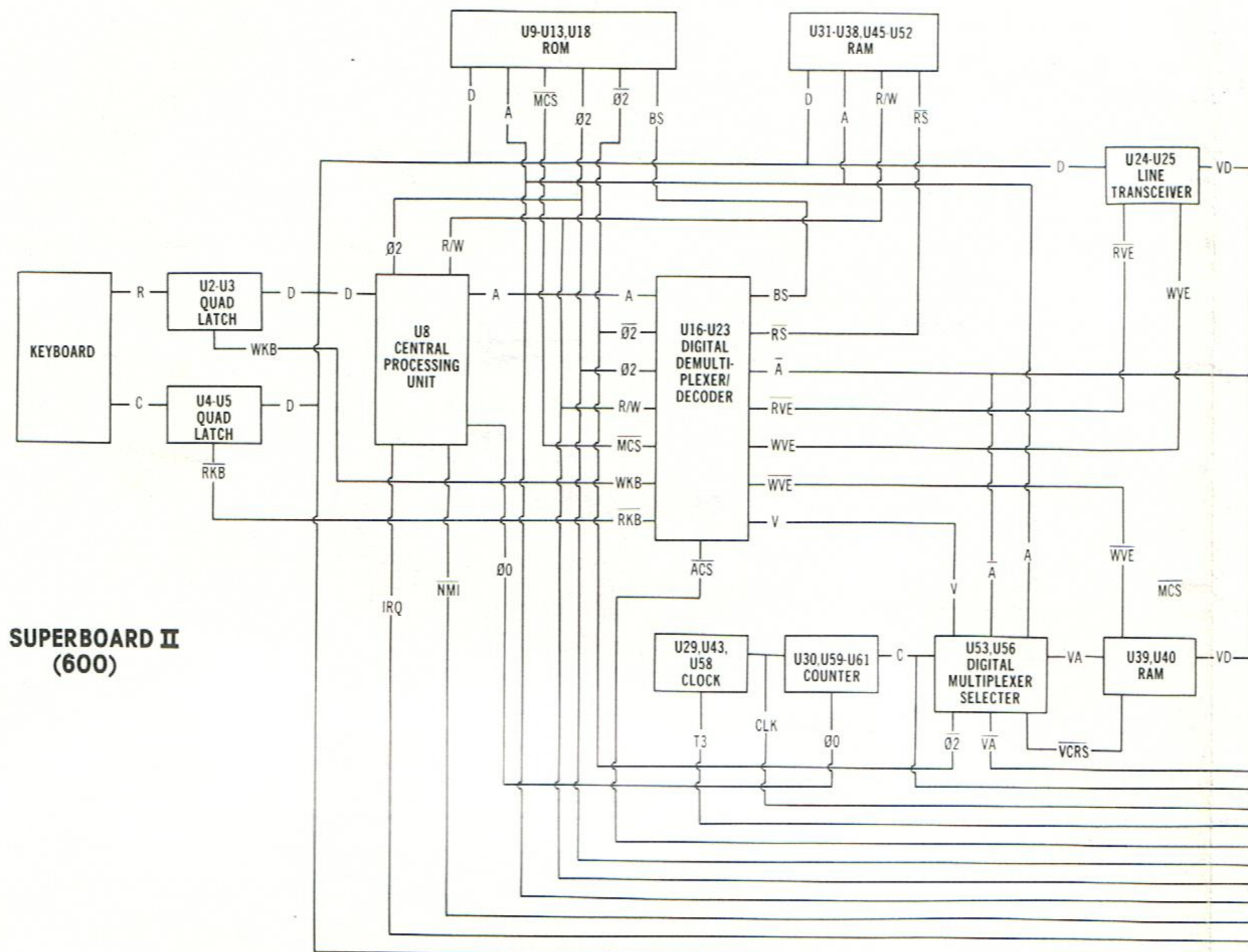

BODY BLOCK DIAGRAM

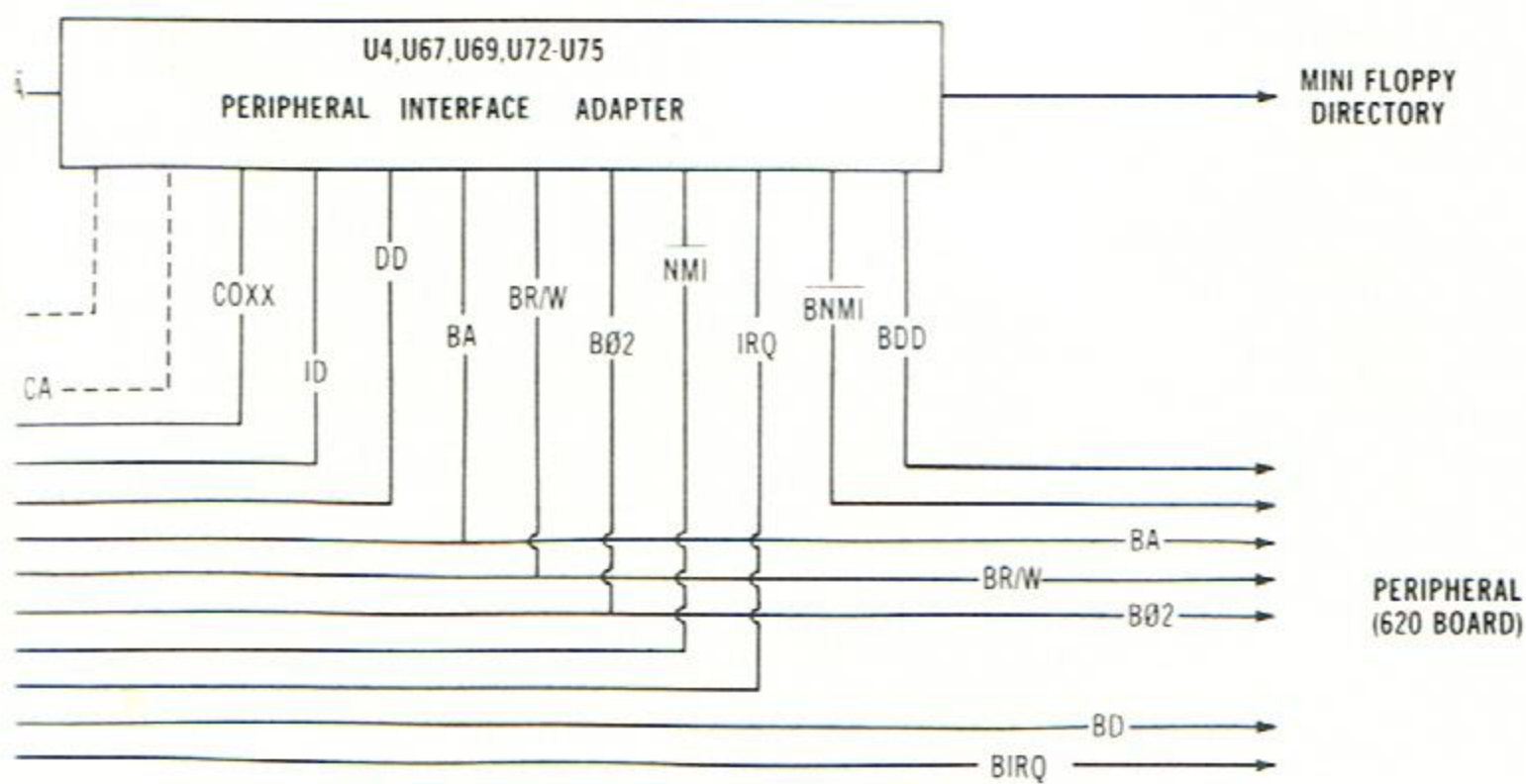
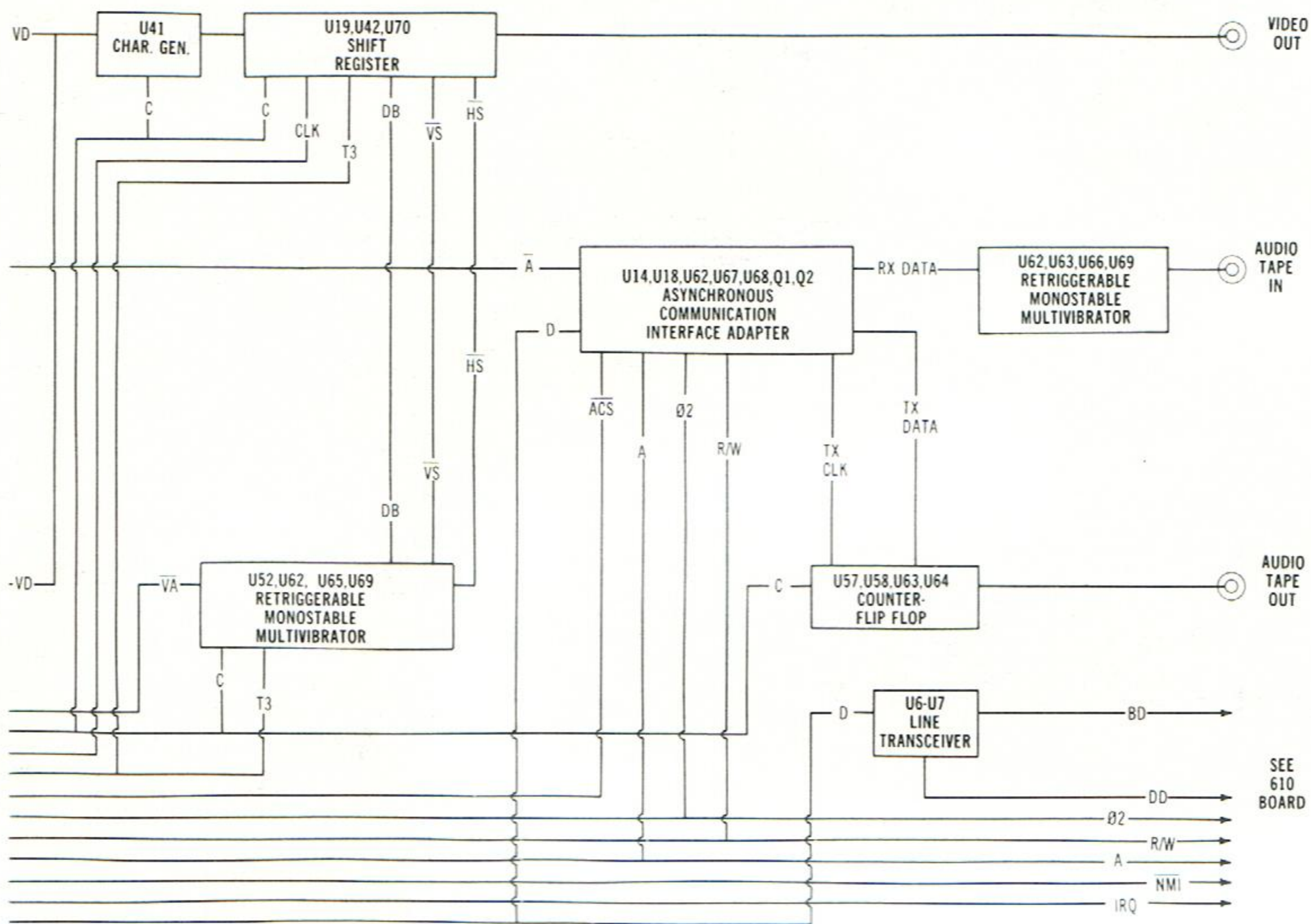

BODY BLOCK DIAGRAM

Waveform 21

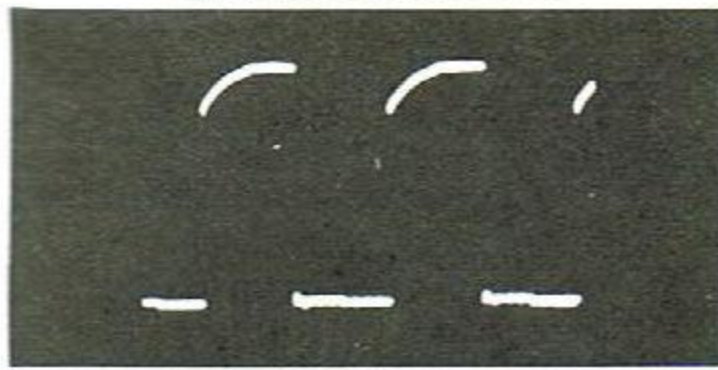

2 μ Sec 4.0V

Waveform 22

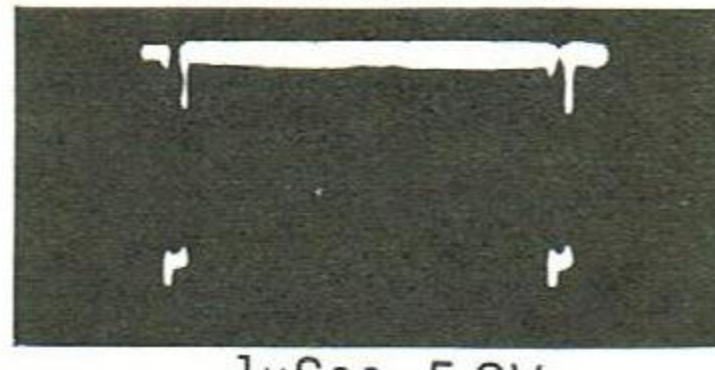

1 μ Sec 5.0V

Waveform 23

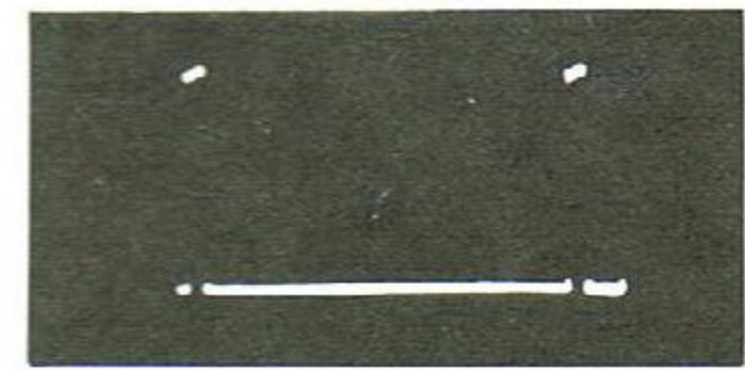

1 μ Sec 4.0V

Waveform 24



50mSec 150mV

Waveform 25

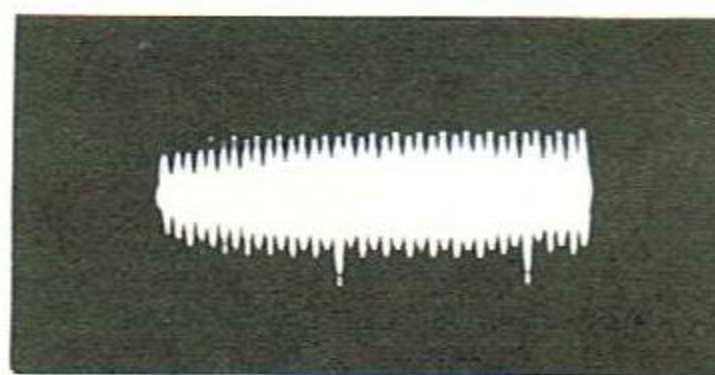

2 μ Sec 0.3V
During directory cycle

Waveform 26



2 μ Sec 0.3V
Program transferred from disk

Waveform 27

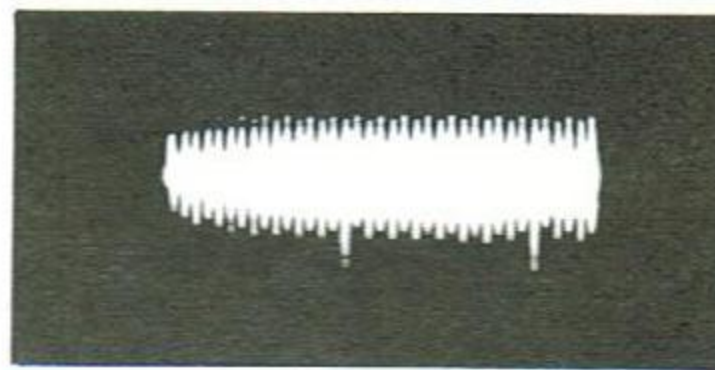

2 μ Sec 0.3V
Program transferred to disk

**WAVEFORMS TAKEN IN "DISK" MODE UNLESS OTHERWISE INDICATED
ELECTRICAL ADJUSTMENT**

R18 TX CLOCK

Remove floppy-disk cable (J3). Input of scope to pin 13 of U68. Adjust R18 for a positive pulse width of 400nSec \pm 50nSec. Reconnect J3.

R9 TX DATA

Remove floppy-disk cable (J3). Input of scope to pin 12 of U68. Adjust R9 for a negative pulse width of 400nSec \pm 50nSec. Reconnect J3.

R10 RX CLOCK

Remove floppy-disk cable (J3). Connect a jumper from pin 9 of J3 to pin 10 of J3. Input of scope to pin 5 of U70. Adjust R10 for a positive pulse width of 1 μ Sec. Remove jumper and reconnect J3.

R19 RX DATA

Remove floppy-disk cable (J3). Connect a jumper from pin 9 of J3 to pin 11 of J3. Input of scope to pin 4 of U70. Adjust R19 for a negative pulse width of 6 μ Sec. Remove jumper and reconnect J3.

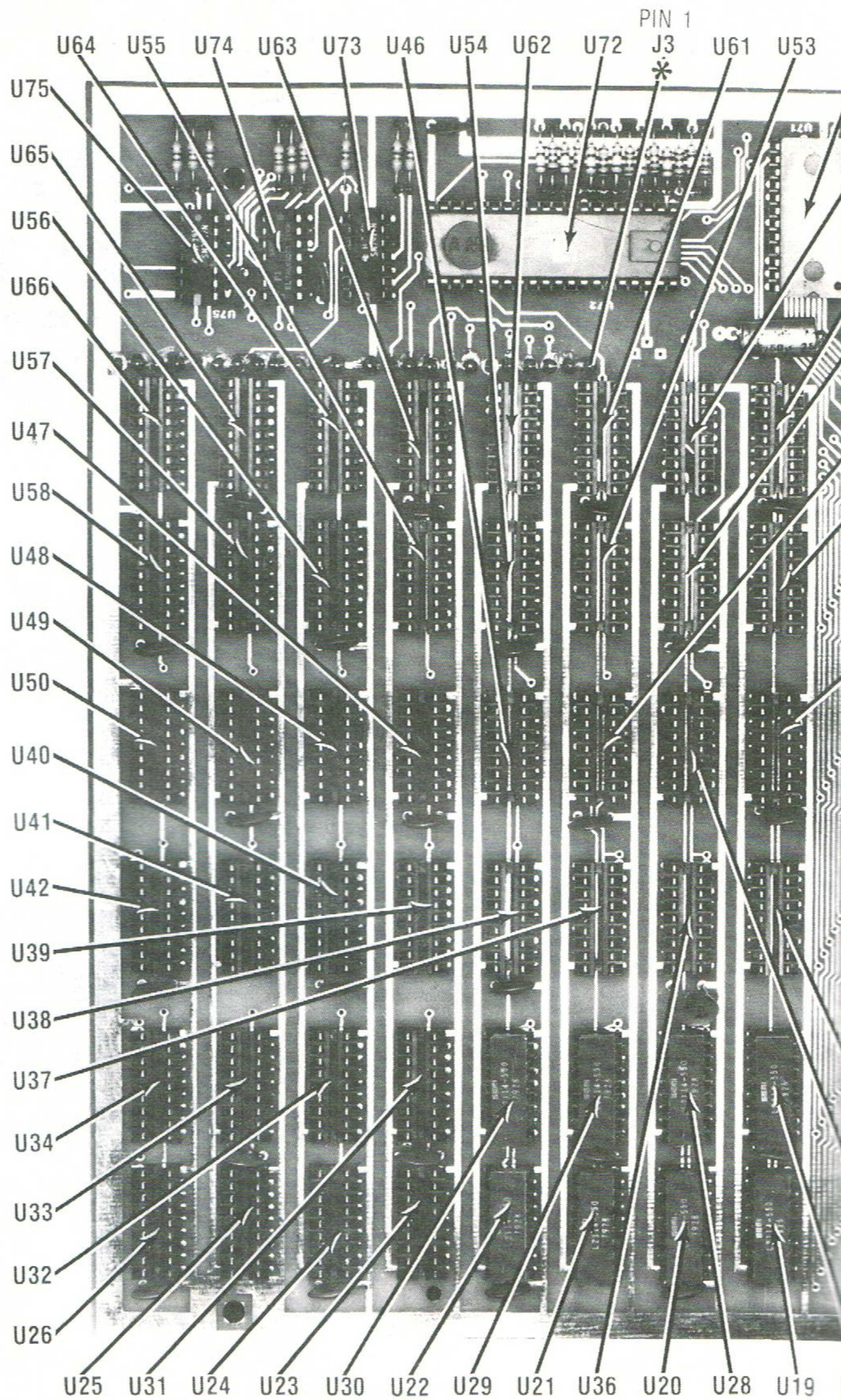

* LOCATED ON OTHER SIDE OF BOARD

610 BOARD

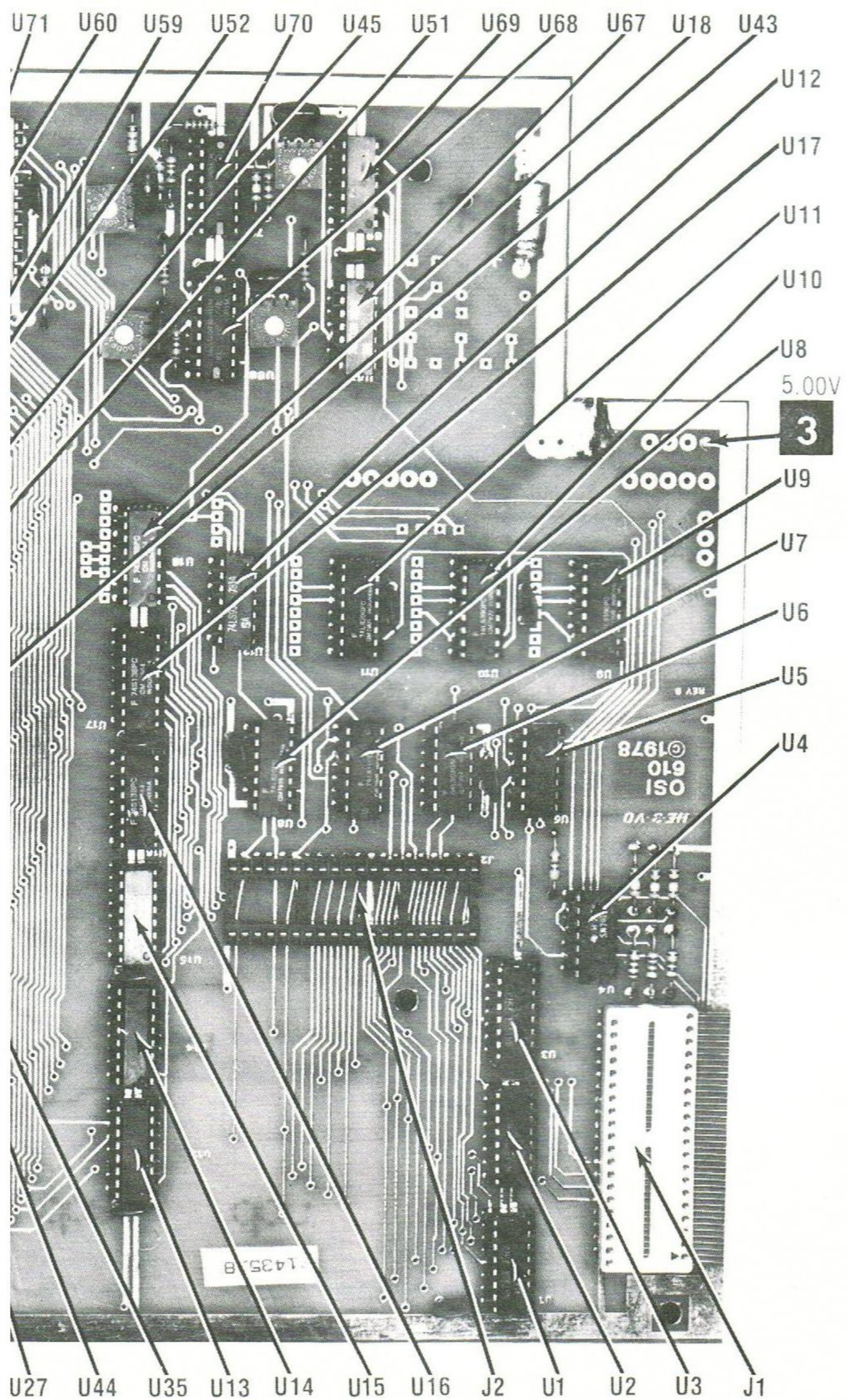

SUPERBOARD II/600 BOARD PINOUTS (CONTINUED)

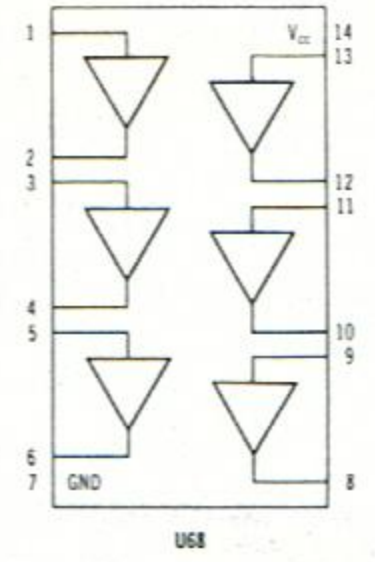
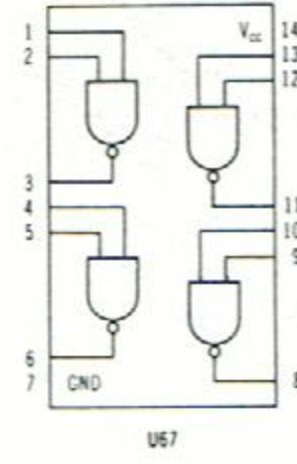
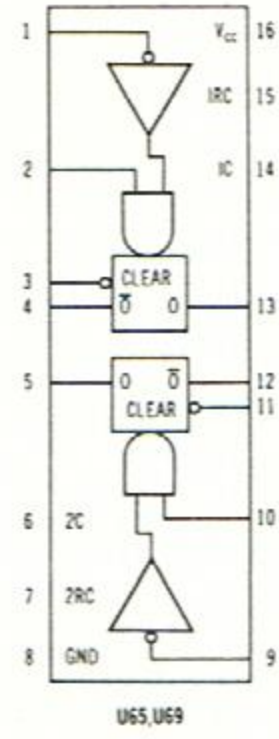

610 BOARD PINOUTS

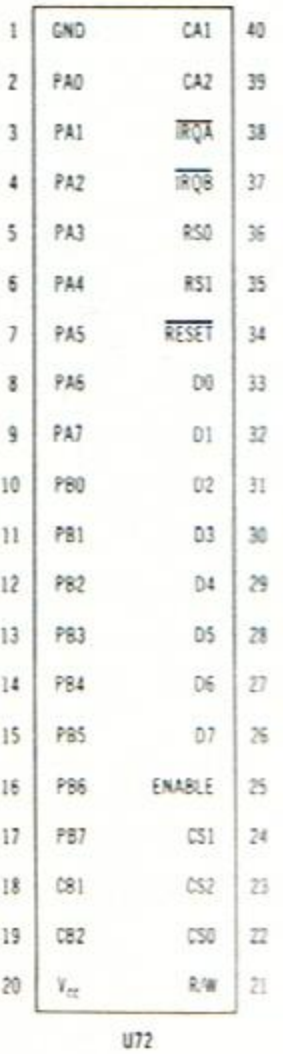
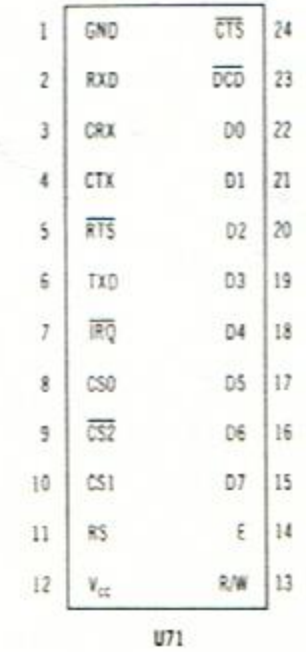
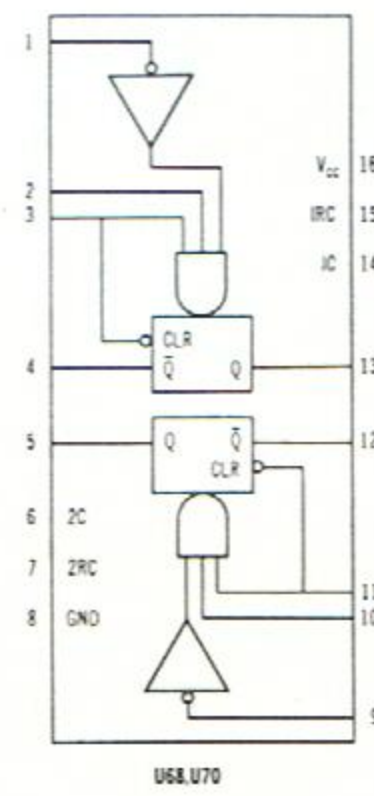
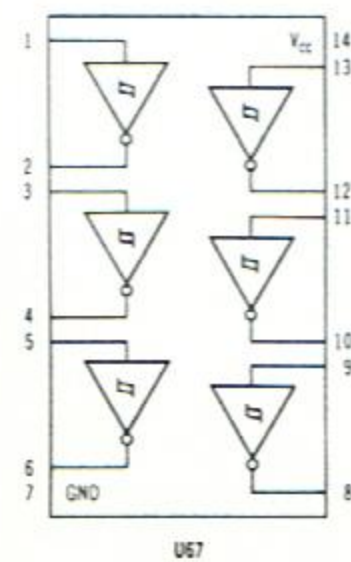
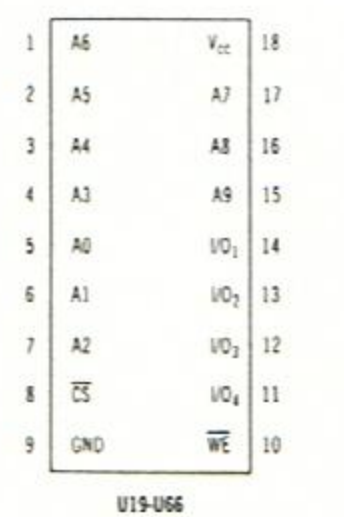
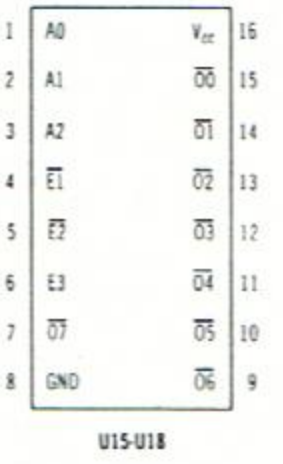
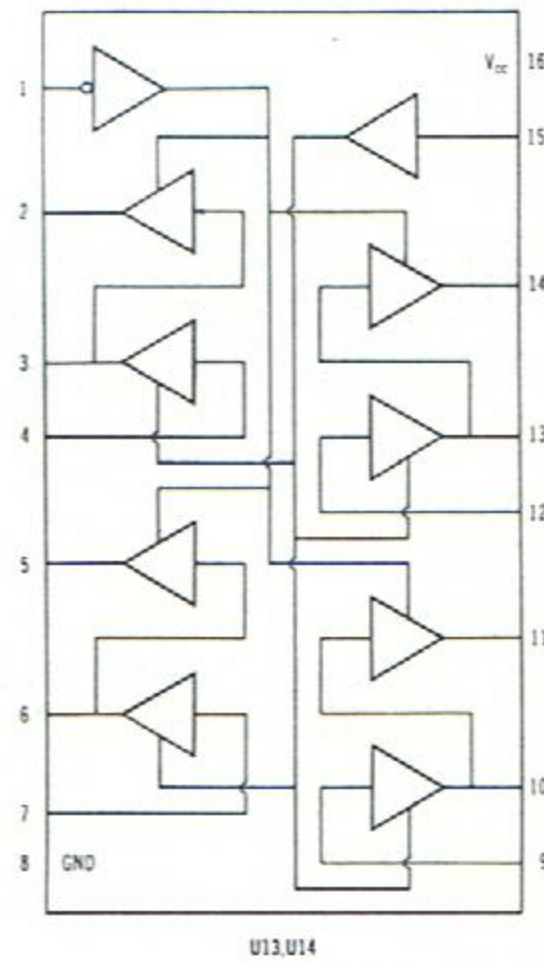
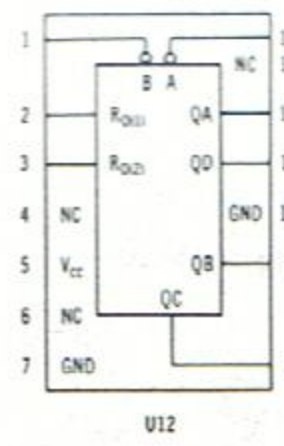
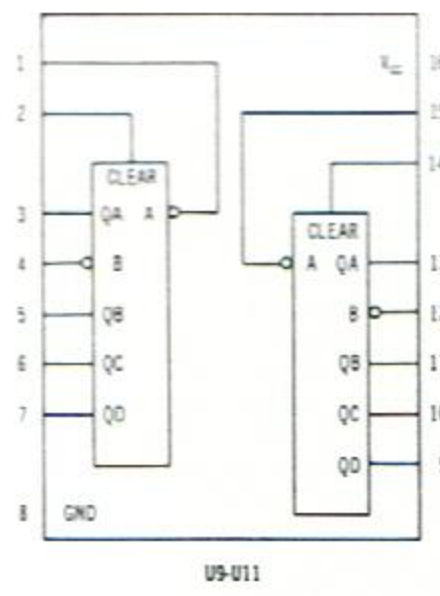
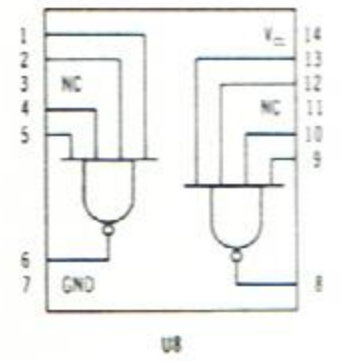
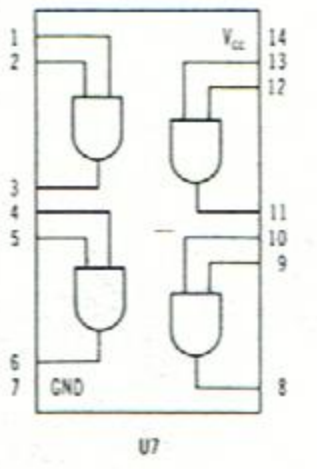
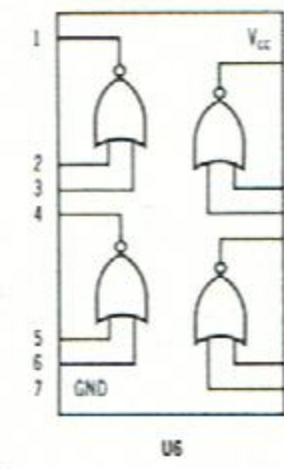
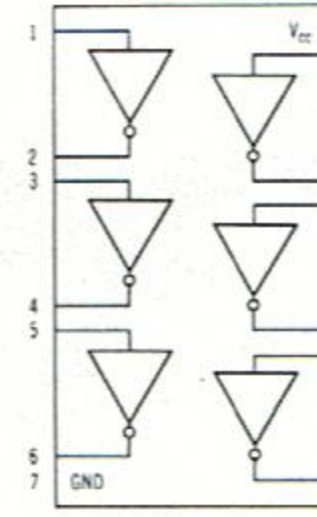
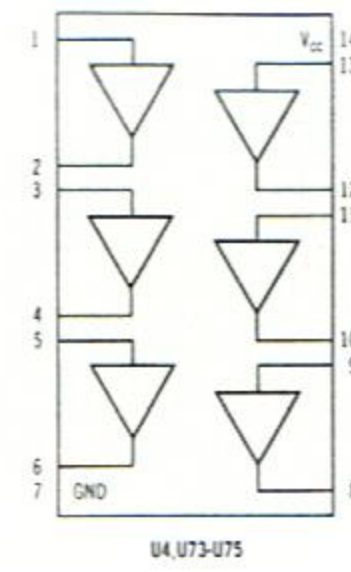
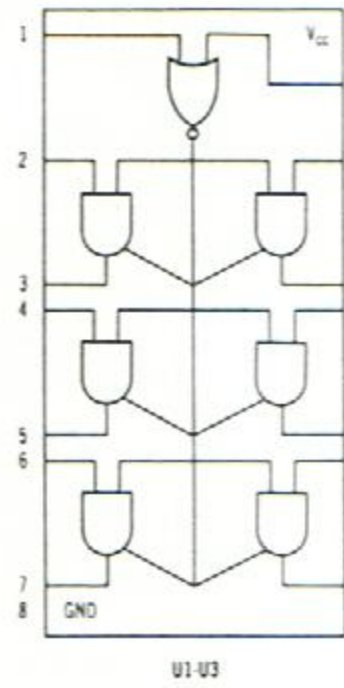

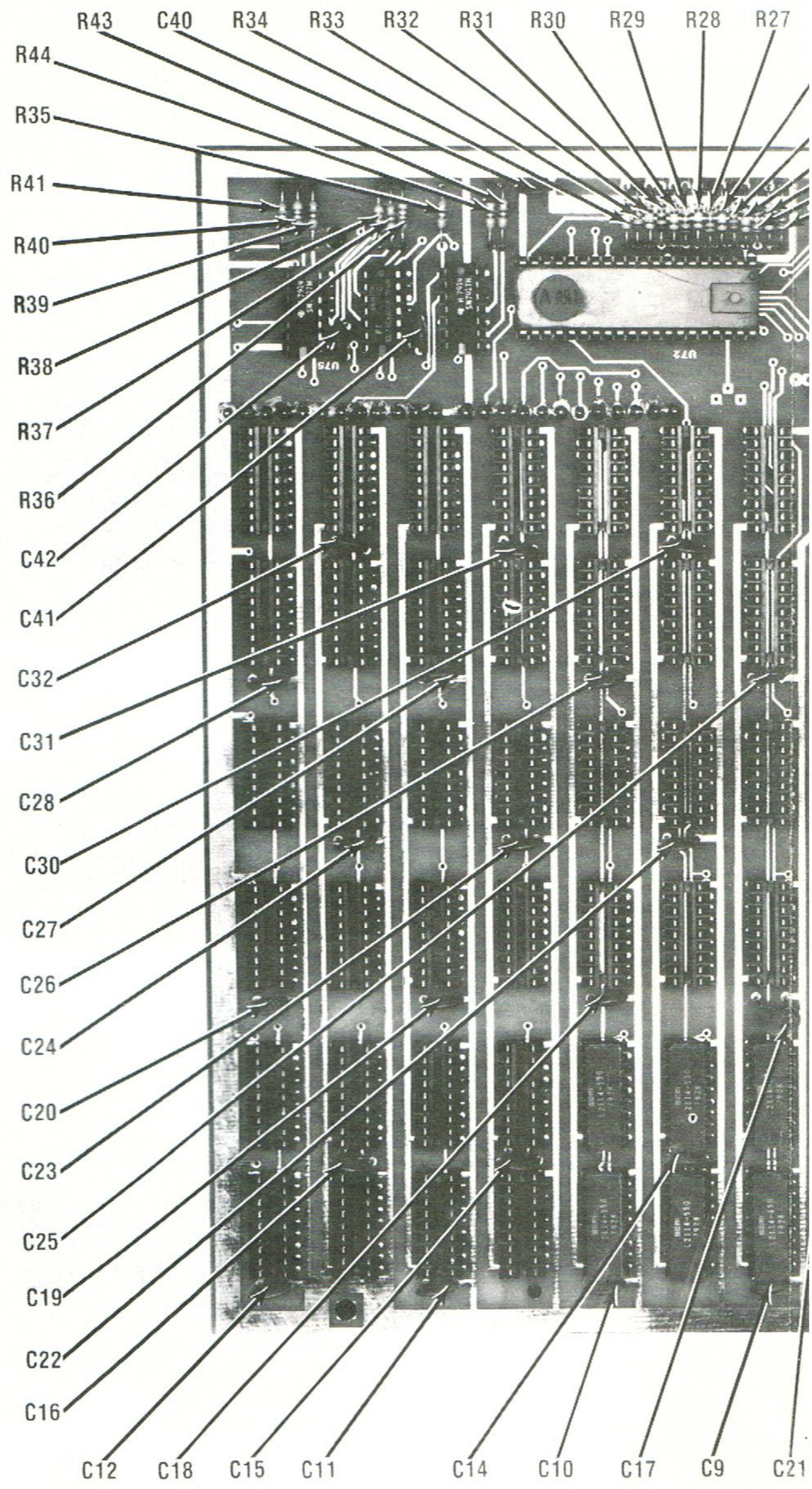

610 BOARD

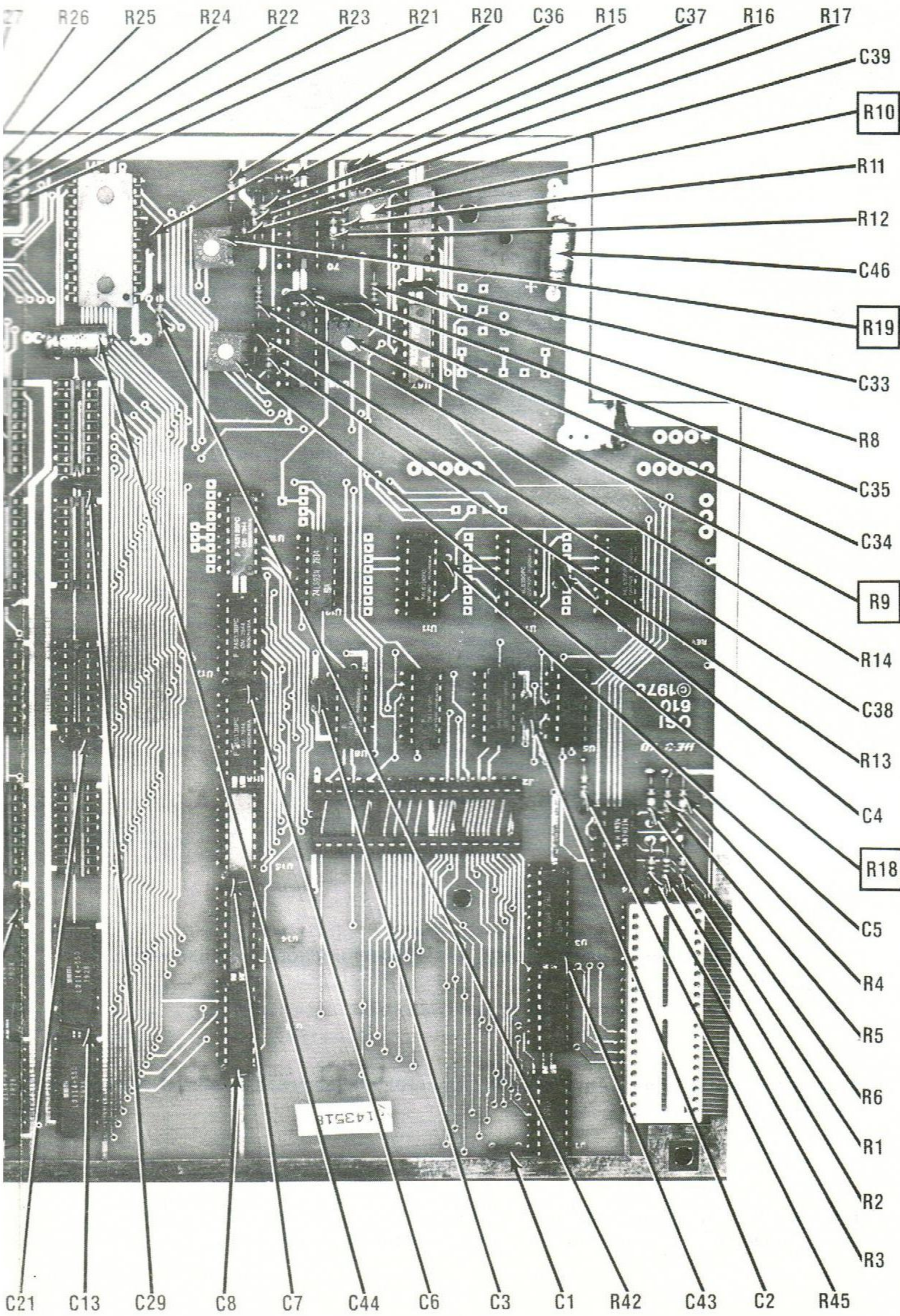

- R26
- R25
- R24
- R22
- R23
- R21
- R20
- C36
- R15
- C37
- R16
- R17
- C39
- R10**
- R11
- R12
- C46
- R19**
- C33
- R8
- C35
- C34
- R9**
- R14
- C38
- R13
- C4
- R18**
- C5
- R4
- R5
- R6
- R1
- R2
- R3
- C21
- C13
- C29
- C8
- C7
- C44
- C6
- C3
- C1
- R42
- C43
- C2
- R45

610 BOARD

LEGEND FOR 600 BOARD SCHEMATIC

A0-A15	Address
ACS	ACIA Chip Select
AUX	Auxiliary for Tape
AD0-BD7	Buffered Data
bRTS	Transmit Data
BS	Basic Rom Select
BS0-BS3	
CN0-CN7	Column
C0-C15	Count
CLK	Clock
CTS	Clear to Send
D	Data
DB	Video Data Blanking
DD	Data Direct
HS	Horizontal Sync.
IRQ	Interrupt Request
MIC	Microphone for Tape
MCS	Monitor Chip Select
VRCS	Video RAM Chip Select
NMI	Non-maskable Chip Select
R	Row
RKB	Read Keyboard
RS0-RS7	Ram Select
RVE	Read Video Enable
R/W	Read/Write
RX CLK	Receive Clock
RX DATA	Receive Data
T1-T4	Time (Clock) Delays
TX CLK	Transmit Clock
TX DATA	Transmit Data
V	Video
VA	Video Address
VD	Video Data
VS	Vertical Sync.
WKB	Write Keyboard
WVE	Write Video Enable
Ø0	Microprocessor Clock In
Ø2	Phase Two
NC	No Connection

Any $\bar{\text{Bar}}$ above any alphabetical or numerical combination indicates line active in a low (0) state.

LEGEND FOR 610 BOARD SCHEMATIC

A0-A15	Address
BA0-BA15	Buffered Address
BD0-BD7	Buffered Data
BDD	Buffered Data Direct
BIRQ	Buffered Interrupt Request
BNMI	Buffered Non-maskable Interrupt
BR/W	Buffered Read/Write
BØ2	Buffered Phase 2
CA	Clocked
CB	Clocked
CE0-CE23	Chip Enable To The Ram(s)
CLR	Clear Real Time Clock
COXX	Address COXX Select
DD	Data Direct
ID0-ID7	Internal Data
IRQ	Interrupt Request
NMI	Non-maskable Interrupt
RX CLK	Receive Clock
RX DATA	Receive Data
R/W	Read/Write
TX CLK	Transmit Clock
TX DATA	Transmit Data
Y1-Y3, Y6	Upper Memory Decode
Ø2	Phase 2
NC	No Connection

Any $\bar{\text{Bar}}$ above any alphabetical or numerical combination indicates line active in a low (0) state.

SCHEMATIC NOTES

- x— Circuitry not used in some versions.
- Circuitry used in some versions.
- ⊗ Nominal value
- ⊕ Ground
- ⏏ Chassis
- ⊖ See parts list

Item numbers in rectangles appear in the alignment/adjustment instructions.
 Supply voltage maintained as shown in input.
 Voltages measured with digital meter.
 Terminal identification may not be found on unit.
 Resistors are ¼W or less, 5% unless noted.
 Value in () used in some versions.

OHIO SCIENTIFIC

**1333 S. Chillicothe Road
Aurora, Ohio 44202**

\$7.95

TM-100